

## Rode Serie

Voor oudere modellen

### Peddicat 360

Peddiworker 400 • 500 • 600 • 800

Peddimaster 450M • 28/40 • 40/60 • 60/80 • 60/100 • 80/110

Hydraulic 40 • 60N • 300 • 500 • 600

210 Super 11 • 13, 210 Standard 11 • 13

Forax 15 • 25 • 45 • 65 • 150 • 250 • 450

### Stanzfix

225 B/11 • 13 • 45 • 60

225 H/11 • 13

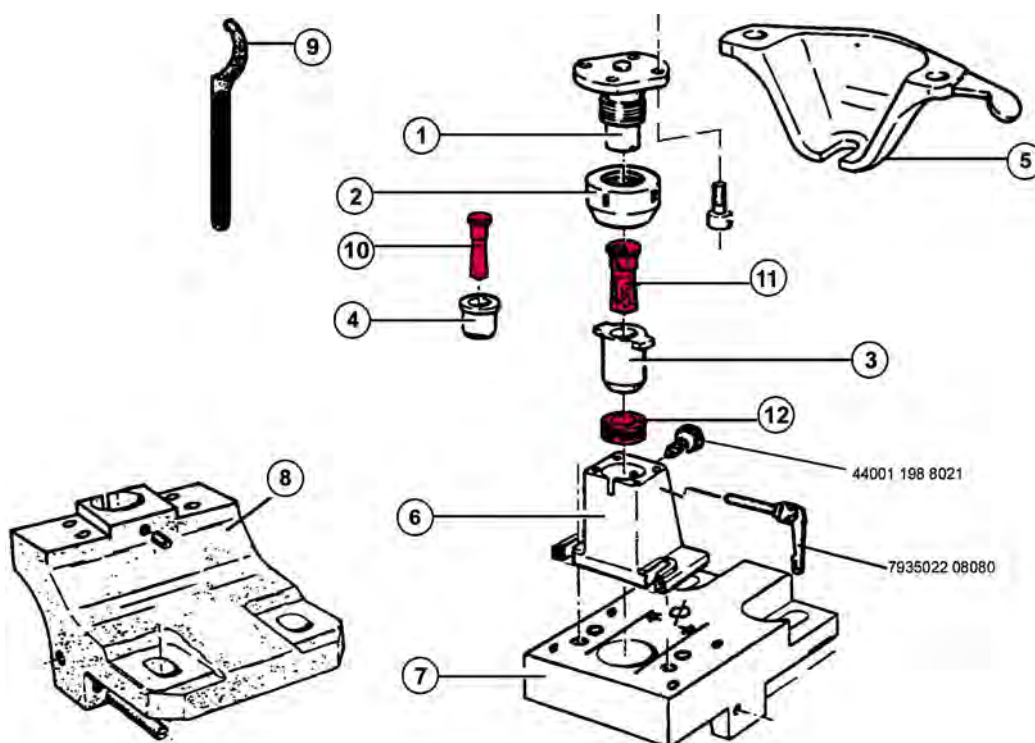

Stempels en matrijzen voor snelwissel-inrichting

## Rode Serie

Rond stempel		Rond stempel		Rond matrijs		Rond matrijs		Excentrisch matrijs	
Nr. 1		Nr. 4		Nr. 2		Nr. 2		Nr. 13	
Bestelnr.	Bestelnr.	Bestelnr.	Bestelnr.	Bestelnr.	Bestelnr.	Bestelnr.	Bestelnr.	Bestelnr.	Bestelnr.
3,0 64001 1030	8,0 64004 1080	3,2 64202 1032	3,2 64202 1032	19,2 64202 1192	5,2 64213 1052	3,2 64001 1032	8,5 64004 1085	3,4 64202 1034	5,7 64213 1057
3,2 64001 1032	8,5 64004 1085	3,4 64202 1034	9,0 64004 1090	19,7 64202 1197	6,2 64213 1062	3,5 64001 1035	9,5 64004 1095	3,7 64202 1037	6,2 64213 1062
3,5 64001 1035	9,0 64004 1090	3,7 64202 1037	10,0 64004 1100	20,2 64202 1202	6,7 64213 1067	4,0 64001 1040	10,5 64004 1105	4,2 64202 1042	6,7 64213 1067
4,0 64001 1040	10,0 64004 1100	4,2 64202 1042	10,5 64004 1105	20,7 64202 1207	7,2 64213 1072	4,2 64001 1042	11,0 64004 1110	4,4 64202 1044	7,2 64213 1072
4,2 64001 1042	10,5 64004 1105	4,4 64202 1044	11,0 64004 1110	21,2 64202 1212	7,7 64213 1077	4,5 64001 1045	11,5 64004 1115	4,7 64202 1047	7,7 64213 1077
4,5 64001 1045	11,0 64004 1110	4,7 64202 1047	11,5 64004 1115	21,7 64202 1217	8,2 64213 1082	5,0 64001 1050	12,0 64004 1120	5,2 64202 1052	8,2 64213 1082
5,0 64001 1050	11,5 64004 1115	5,2 64202 1052	12,0 64004 1120	22,2 64202 1222	8,7 64213 1087	5,5 64001 1055	12,5 64004 1125	5,7 64202 1057	8,7 64213 1087
5,5 64001 1055	12,0 64004 1120	5,7 64202 1057	12,5 64004 1125	22,7 64202 1227	9,2 64213 1092	6,0 64001 1060	13,0 64004 1130	6,2 64202 1062	9,2 64213 1092
6,0 64001 1060	12,5 64004 1125	6,2 64202 1062	13,0 64004 1130	23,2 64202 1232	9,7 64213 1097	6,5 64001 1065	13,5 64004 1135	6,7 64202 1067	9,7 64213 1097
6,5 64001 1065	13,0 64004 1130	6,7 64202 1067	13,5 64004 1135	23,7 64202 1237	10,2 64213 1102	7,0 64001 1070	14,0 64004 1140	7,2 64202 1072	10,2 64213 1102
7,0 64001 1070	13,5 64004 1135	7,2 64202 1072	14,0 64004 1140	24,2 64202 1242	10,7 64213 1107	7,5 64001 1075	14,5 64004 1145	7,7 64202 1077	10,7 64213 1107
7,5 64001 1075	14,0 64004 1140	7,7 64202 1077	14,5 64004 1145	24,7 64202 1247	11,2 64213 1112	8,0 64001 1080	15,0 64004 1150	8,2 64202 1082	11,2 64213 1112
8,0 64001 1080	14,5 64004 1145	8,2 64202 1082	15,0 64004 1150	25,2 64202 1252	11,7 64213 1117	8,5 64001 1085	15,5 64004 1155	8,7 64202 1087	11,7 64213 1117
8,5 64001 1085	15,0 64004 1150	8,7 64202 1087	15,5 64004 1155	25,7 64202 1257	12,2 64213 1122	9,0 64001 1090	16,0 64004 1160	9,2 64202 1092	12,2 64213 1122
9,0 64001 1090	15,5 64004 1155	9,2 64202 1092	16,0 64004 1160	26,2 64202 1262	12,7 64213 1127	9,5 64001 1095	16,5 64004 1165	9,7 64202 1097	12,7 64213 1127
9,5 64001 1095	16,0 64004 1160	9,7 64202 1097	16,5 64004 1165	26,7 64202 1267	13,2 64213 1132	10,0 64001 1100	17,0 64004 1170	10,2 64202 1102	13,2 64213 1132
10,0 64001 1100	16,5 64004 1165	10,2 64202 1102	17,0 64004 1170	27,2 64202 1272	13,7 64213 1137	10,5 64001 1105	17,5 64004 1175	10,7 64202 1107	13,7 64213 1137
10,5 64001 1105	17,0 64004 1170	10,7 64202 1107	17,5 64004 1175	27,7 64202 1277	14,2 64213 1142	11,0 64001 1110	18,0 64004 1180	11,2 64202 1112	14,2 64213 1142
11,0 64001 1110	17,5 64004 1175	11,2 64202 1112	18,0 64004 1180	28,2 64202 1282	14,7 64213 1147	11,5 64001 1115	18,5 64004 1185	11,7 64202 1117	14,7 64213 1147
11,5 64001 1115	18,0 64004 1180	11,7 64202 1117	18,5 64004 1185	28,7 64202 1287	15,2 64213 1152	12,0 64001 1120	19,0 64004 1190	12,2 64202 1122	15,2 64213 1152
12,0 64001 1120	18,5 64004 1185	12,2 64202 1122	19,0 64004 1190	29,2 64202 1292	15,7 64213 1157	12,5 64001 1125	19,5 64004 1195	12,7 64202 1127	15,7 64213 1157
12,5 64001 1125	19,0 64004 1190	12,7 64202 1127	19,5 64004 1195	29,7 64202 1297	16,2 64213 1162	13,0 64001 1130	20,0 64004 1200	13,2 64202 1132	16,2 64213 1162
13,0 64001 1130	19,5 64004 1195	13,2 64202 1132	20,0 64004 1200	30,2 64202 1302	16,7 64213 1167	13,5 64001 1135	20,5 64004 1205	13,7 64202 1137	16,7 64213 1167
13,5 64001 1135	20,0 64004 1200	13,7 64202 1137	20,5 64004 1205	30,7 64202 1307	17,2 64213 1172	14,0 64001 1140	21,0 64004 1210	14,2 64202 1142	17,2 64213 1172
14,0 64001 1140	20,5 64004 1205	14,2 64202 1142	21,0 64004 1210		17,7 64213 1177	14,5 64001 1145	21,5 64004 1215	14,7 64202 1147	17,7 64213 1177
	21,0 64004 1210	14,7 64202 1147	21,5 64004 1215		18,2 64213 1182	15,0 64001 1150	22,0 64004 1220	15,2 64202 1152	18,2 64213 1182
	21,5 64004 1215	15,2 64202 1152	22,0 64004 1220		18,7 64213 1187	15,5 64001 1155	22,5 64004 1225	15,7 64202 1157	18,7 64213 1187
	22,0 64004 1220	15,7 64202 1157	22,5 64004 1225			16,0 64001 1160	23,0 64004 1230	16,2 64202 1162	19,2 64213 1192
	22,5 64004 1225	16,2 64202 1162	23,0 64004 1230			16,5 64001 1165	23,5 64004 1235	16,7 64202 1167	19,7 64213 1197
	23,0 64004 1230	16,7 64202 1167	23,5 64004 1235			17,0 64001 1170	24,0 64004 1240	17,2 64202 1172	20,2 64213 1202
	23,5 64004 1235	17,2 64202 1172	24,0 64004 1240			17,5 64001 1175	24,5 64004 1245	17,7 64202 1177	20,7 64213 1207
	24,0 64004 1240	17,7 64202 1177	24,5 64004 1245			18,0 64001 1180	25,0 64004 1250	18,2 64202 1182	21,2 64213 1212
	24,5 64004 1245	18,2 64202 1182	25,0 64004 1250			18,5 64001 1185	25,5 64004 1255	18,7 64202 1187	21,7 64213 1217
	25,0 64004 1250	18,7 64202 1187	25,5 64004 1255			19,0 64001 1190	26,0 64004 1260	22,2 64213 1222	22,2 64213 1222
	25,5 64004 1255		26,0 64004 1260			19,5 64001 1195	26,5 64004 1265	22,7 64213 1227	22,7 64213 1227
	26,0 64004 1260		26,5 64004 1265			20,0 64004 1200	27,0 64004 1270		
	26,5 64004 1265		27,0 64004 1270						



Reduceerhuls 1/4

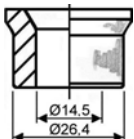

44001 198 503

\*Overmaat:

- 28,0 64004 1280
- 29,0 64004 1290
- 30,0 64004 1300

\*Overmaat, hiervoor is nodig:

- snelspaninzet tbv. overmaat
- 44001 6 3523 01

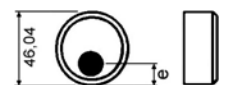

## Rode Serie

Vierkant stempel		Vierkant matrijs		Langgat stempel		Langgat matrijs	
Nr. 1		Nr. 2		Nr. 1		Nr. 2	
	Bestelnr.		Bestelnr.		Bestelnr.		Bestelnr.
4,0	64001 2040	4,2	64202 2042	5,0 × 10	64001 3050100	5,2 × 10,2	64202 3 052102
5,0	64001 2050	5,2	64202 2052			5,7 × 10,7	64202 3 057107
6,0	64001 2060	6,2	64202 2062	5,0 × 14	64001 3050140	5,2 × 14,2	64202 3 052142
7,0	64001 2070	6,7	64202 2067			5,7 × 14,7	64202 3 057147
8,0	64001 2080	7,2	64202 2072	5,5 × 10	64001 3055100	5,7 × 10,2	64202 3 057102
9,0	64001 2090	7,7	64202 2077			6,2 × 10,7	64202 3 062107
10,0	64001 2100	8,2	64202 2082	5,5 × 14	64001 3055140	5,7 × 14,2	64202 3 057142
		8,7	64202 2087			6,2 × 14,7	64202 3 062147
		9,2	64202 2092	6,5 × 12	64001 3065120	6,7 × 12,2	64202 3 067122
		9,7	64202 2097			7,2 × 12,7	64202 3 072127
		10,2	64202 2102	7,5 × 14	64001 3075140	7,7 × 14,2	64202 3 077142
		10,7	64202 2107			8,2 × 14,7	64202 3 082147
		11,2	64202 2112	9,0 × 14	64001 3090140	9,2 × 14,2	64202 3 092142
		11,7	64202 2117			9,7 × 14,7	64202 3 097147
		12,2	64202 2122	10,0 × 14	64001 3100140	10,2 × 14,2	64202 3 102142
		12,7	64202 2127			10,7 × 14,7	64202 3 107147
		13,2	64202 2132				
		13,7	64202 2137				
		14,2	64202 2142				
		14,7	64202 2147				
		15,2	64202 2152				
		15,7	64202 2157				
		16,2	64202 2162				
		16,7	64202 2167				
		17,2	64202 2172				
		17,7	64202 2177				
		18,2	64202 2182				
		18,7	64202 2187				
		19,2	64202 2192				
		19,7	64202 2197				
		20,2	64202 2202				
		20,7	64202 2207				
		21,2	64202 2212				
		21,7	64202 2217				

### Vierkant stempel

#### Nr. 4

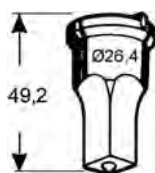

	Bestelnr.
11,0	64004 2110
12,0	64004 2120
13,0	64004 2130
14,0	64004 2140
15,0	64004 2150
16,0	64004 2160
17,0	64004 2170
18,0	64004 2180
19,0	64004 2190
20,0*	64004 2200
21,0*	64004 2210

\*Overmaat





hiervoor is nodig:



65004 8087 01 snelspanzet tbv. overmaat



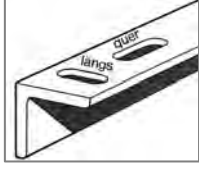





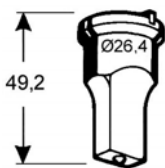
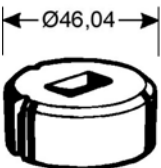
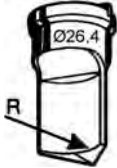

Materiaaldikte	Snijspeling:
tot 4 mm	0,2 mm
4 tot 9 mm	0,7 mm
9 tot 14 mm	1,2 mm

## Rode Serie

Langgat stempel	Langgat matrijs	Excentrisch matrijs langgat langs	Excentrisch matrijs langgat dwars
Nr. 4	Nr. 2	Nr. 13	Nr. 13
		 	
Bestelnr.	Bestelnr.	Bestelnr.	Bestelnr.
<b>5,5 × 19</b> 64004 3055190 <b>5,5 × 25</b> 64004 3055250 <b>6,5 × 18</b> 64004 3065180 <b>6,5 × 26</b> 64004 3065260 <b>7,5 × 21</b> 64004 3075210 <b>7,5 × 26</b> 64004 3075260 <b>9,0 × 18</b> 64004 3090180 <b>9,0 × 26</b> 64004 3090260 <b>10,0 × 20</b> 64004 3100200 <b>10,0 × 26</b> 64004 3100260 <b>11,0 × 22</b> 64004 3110220 <b>11,0 × 26</b> 64004 3110260 <b>12,0 × 24</b> 64004 3120240 <b>13,0 × 26</b> 64004 3130260 <b>14,0 × 26</b> 64004 3140260 <b>16,0 × 26</b> 64004 3160260 <b>18,0 × 26</b> 64004 3180260	<b>5,7 × 19,2</b> 64202 3 057192 <b>6,2 × 19,7</b> 64202 3 062197 <b>5,7 × 25,2</b> 64202 3 057252 <b>6,2 × 25,7</b> 64202 3 062257 <b>6,7 × 18,2</b> 64202 3 067182 <b>7,2 × 18,7</b> 64202 3 072187 <b>6,7 × 26,2</b> 64202 3 067262 <b>7,2 × 26,7</b> 64202 3 072267 <b>7,7 × 21,2</b> 64202 3 077212 <b>8,2 × 21,7</b> 64202 3 082217 <b>7,7 × 26,2</b> 64202 3 077262 <b>8,2 × 26,7</b> 64202 3 082267 <b>9,2 × 18,2</b> 64202 3 092182 <b>9,7 × 18,7</b> 64202 3 097187 <b>9,2 × 26,2</b> 64202 3 092262 <b>9,7 × 26,7</b> 64202 3 097267 <b>10,2 × 20,2</b> 64202 3 102202 <b>10,7 × 20,7</b> 64202 3 107207 <b>10,2 × 26,2</b> 64202 3 102262 <b>10,7 × 26,7</b> 64202 3 107267 <b>11,2 × 22,2</b> 64202 3 112222 <b>11,7 × 22,7</b> 64202 3 117227 <b>11,2 × 26,2</b> 64202 3 112262 <b>11,7 × 26,7</b> 64202 3 117267 <b>12,2 × 24,2</b> 64202 3 122242 <b>12,7 × 24,7</b> 64202 3 127247 <b>13,2 × 26,2</b> 64202 3 132262 <b>13,7 × 26,7</b> 64202 3 137267 <b>14,2 × 26,2</b> 64202 3 142262 <b>14,7 × 26,7</b> 64202 3 147267 <b>16,2 × 26,2</b> 64202 3 162262 <b>16,7 × 26,7</b> 64202 3 167267 <b>18,2 × 26,2</b> 64202 3 182262 <b>18,7 × 26,7</b> 64202 3 187267	<b>6,2 × 14,7</b> 64213 3 062147 <b>9,7 × 14,7</b> 64213 3 097147  <b>6,2 × 25,7</b> 64213 3 062257  <b>7,2 × 26,7</b> 64213 3 072267  <b>8,2 × 26,7</b> 64213 3 082267  <b>9,7 × 26,7</b> 64213 3 097267  <b>10,7 × 20,7</b> 64213 3 107207  <b>11,7 × 22,7</b> 64213 3 117227  <b>11,7 × 26,7</b> 64213 3 117267  <b>13,7 × 26,7</b> 64213 3 137267  <b>14,7 × 26,7</b> 64213 3 147267  <b>16,7 × 26,7</b> 64213 3 167267	<b>6,2 × 14,7</b> 64213 4 062147 <b>9,7 × 14,7</b> 64213 4 097147  <b>6,2 × 25,7</b> 64213 4 062257  <b>7,2 × 26,7</b> 64213 4 072267  <b>8,2 × 26,7</b> 64213 4 082267  <b>9,7 × 26,7</b> 64213 4 097267  <b>10,7 × 20,7</b> 64213 4 107207  <b>11,7 × 22,7</b> 64213 4 117227  <b>11,7 × 26,7</b> 64213 4 117267  <b>13,7 × 26,7</b> 64213 4 137267  <b>14,7 × 26,7</b> 64213 4 147267  <b>16,7 × 26,7</b> 64213 4 167267

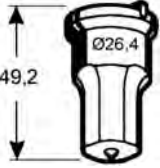
Snijspeling: **0,2 mm** (Materiaaldikte: tot 4 mm) • **0,7 mm** (Materiaaldikte: 4 tot 9 mm)

## Rode Serie

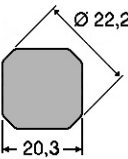
Rechthoek stempel	Rechthoek matrijs	Hoekafrond stempel	Hoekafrond matrijs
Nr. 4	Nr. 2	Nr. 4	Nr. 2
			
 Bestelnr.	 Bestelnr.	 Bestelnr.	 Bestelnr.
<p><b>5,0 × 15</b>    64004 5 050150</p> <p><b>5,0 × 20</b>    64004 5 050200</p> <p><b>6,0 × 24</b>    64004 5 060240</p> <p><b>8,0 × 16</b>    64004 5 080160</p> <p><b>8,0 × 24</b>    64004 5 080240</p> <p><b>9,0 × 24</b>    64004 5 090240</p> <p><b>10,0 × 20</b>    64004 5 100200</p> <p><b>11,0 × 22</b>    64004 5 110220</p> <p><b>12,0 × 22</b>    64004 5 120220</p> <p><b>14,0 × 20</b>    64004 5 140200</p> <p><b>16,0 × 20</b>    64004 5 160200</p>	<p><b>5,2 × 15,2</b>    64202 5 052152</p> <p><b>5,7 × 15,7</b>    64202 5 057157</p> <p><b>5,2 × 20,2</b>    64202 5 052202</p> <p><b>5,7 × 20,7</b>    64202 5 057207</p> <p><b>6,2 × 24,2</b>    64202 5 062242</p> <p><b>6,7 × 24,7</b>    64202 5 067247</p> <p><b>8,2 × 16,2</b>    64202 5 082162</p> <p><b>8,7 × 16,7</b>    64202 5 087167</p> <p><b>8,2 × 24,2</b>    64202 5 082242</p> <p><b>8,7 × 24,7</b>    64202 5 087247</p> <p><b>9,2 × 24,2</b>    64202 5 092242</p> <p><b>9,7 × 24,7</b>    64202 5 097247</p> <p><b>10,2 × 20,2</b>    64202 5 102202</p> <p><b>10,7 × 20,7</b>    64202 5 107207</p> <p><b>11,2 × 22,2</b>    64202 5 112222</p> <p><b>11,7 × 22,7</b>    64202 5 117227</p> <p><b>12,2 × 22,2</b>    64202 5 122222</p> <p><b>12,7 × 22,7</b>    64202 5 127227</p> <p><b>14,2 × 20,2</b>    64202 5 142202</p> <p><b>14,7 × 20,7</b>    64202 5 147207</p> <p><b>16,2 × 20,2</b>    64202 5 162202</p> <p><b>16,7 × 20,7</b>    64202 5 167207</p>	<p><b>Radius</b></p> <p><b>5</b>            65004 37 00050</p> <p><b>10</b>           65004 37 00100</p> <p><b>14</b>           65004 37 00140</p>	<p><b>Radius</b></p> <p><b>5</b>            65202 37 00050</p> <p><b>10</b>           65202 37 00100</p> <p><b>14</b>           65202 37 00140</p>
		Spanjolet stempel	Spanjolet matrijs
		Nr. 4	Nr. 2
			
		 Bestelnr.	 Bestelnr.
		<b>Ø 22,2 × 20,3</b> 65004 38 222203	<b>Ø 22,4 × 20,5</b> 65202 38 224205
			

Materiaaldikte







tot 4 mm  
4 –tot9 mm

Snijspeling

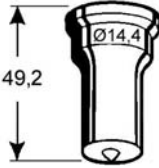
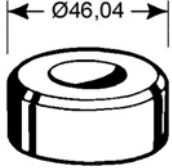
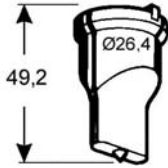
0,2 mm  
0,7 mm

## Rode Serie

### Speciale stempels voor ponsen in RVS

Rond stempel, speciaal	Rond matrijs (standaard)	Langgat stempel, speciaal	Langgat matrijs (standaard)
Nr. 1	Nr. 2	Nr. 4	Nr. 2
			
 Bestelnr.	 Bestelnr.	 Bestelnr.	 Bestelnr.
<b>3,0</b> P-65001 8004 030 <b>4,0</b> P-65001 8004 040 <b>4,5</b> P-65001 8004 045 <b>5,0</b> P-65001 8004 050  <b>6,0</b> P-65001 8004 060 <b>7,0</b> P-65001 8004 070 <b>8,0</b> P-65001 8004 080 <b>9,0</b> P-65001 8004 090 <b>10,0</b> P-65001 8004 100 <b>11,0</b> P-65001 8004 110 <b>12,0</b> P-65001 8004 120 <b>13,0</b> P-65001 8004 130 <b>14,0</b> P-65001 8004 140	<b>3,2</b> 64202 1032 <b>3,7</b> 64202 1037 <b>4,2</b> 64202 1042 <b>4,7</b> 64202 1047 <b>5,2</b> 64202 1052 <b>5,7</b> 64202 1057 <b>6,2</b> 64202 1062 <b>6,7</b> 64202 1067 <b>7,2</b> 64202 1072 <b>7,7</b> 64202 1077 <b>8,2</b> 64202 1072 <b>8,7</b> 64202 1077 <b>9,2</b> 64202 1092 <b>9,7</b> 64202 1097 <b>10,2</b> 64202 1102 <b>10,7</b> 64202 1107 <b>11,2</b> 64202 1112 <b>11,7</b> 64202 1117 <b>12,2</b> 64202 1122 <b>12,7</b> 64202 1127 <b>13,2</b> 64202 1132 <b>13,7</b> 64202 1137 <b>14,2</b> 64202 1142 <b>14,7</b> 64202 1147 <b>15,2</b> 64202 1152	<b>9,0 × 26,0</b> P-65004 8008 01  <b>11,0 × 26,0</b> P-65004 8008 02  <b>13,0 × 26,0</b> P-65004 8008 03	<b>9,7 × 26,7</b> 64202 3 097267  <b>11,7 × 26,7</b> 64202 3 117267 <b>12,2 × 27,2</b> 64202 3 122272  <b>13,7 × 26,7</b> 64202 3 137267 <b>14,2 × 27,2</b> 64202 3 142272

Materiaaldikte

Snijspeling

tot 4 mm  
 4 tot 9 mm  
 9 –tot14 mm

0,2 mm  
 0,7 mm  
 1,2 mm