

## Série verte

para las cizallas / punzonadoras:

**Peddibasic No. 1**  
**Peddicat No. 1**  
**Peddiworker No. 1**

**Hydraulic 280**  
**Hydraulic 502**  
**Hydraulic 801**

para las máquinas de catálogos antiguos::

**Peddicat 361 • 380 • 500**  
**Peddiworker 501 • 502 • 801 • 802 • 1000 G**  
**Peddimaster 100/160 • 110/170 • 800/1100 • 1100/1700**  
**Peddimax 600 • 601 • 602 • 800 • 801 • 1002 • 110/140**  
**Hydraulic 100 • 301 • 501 • 800 • 1000 • 1001**  
**210 Super 16 • 20, 210 Standard 16**  
**Forax 80 • 100 • 1000**  
**225 B/16 • 20 • 80 • 100**  
**225 H/15 • 20**

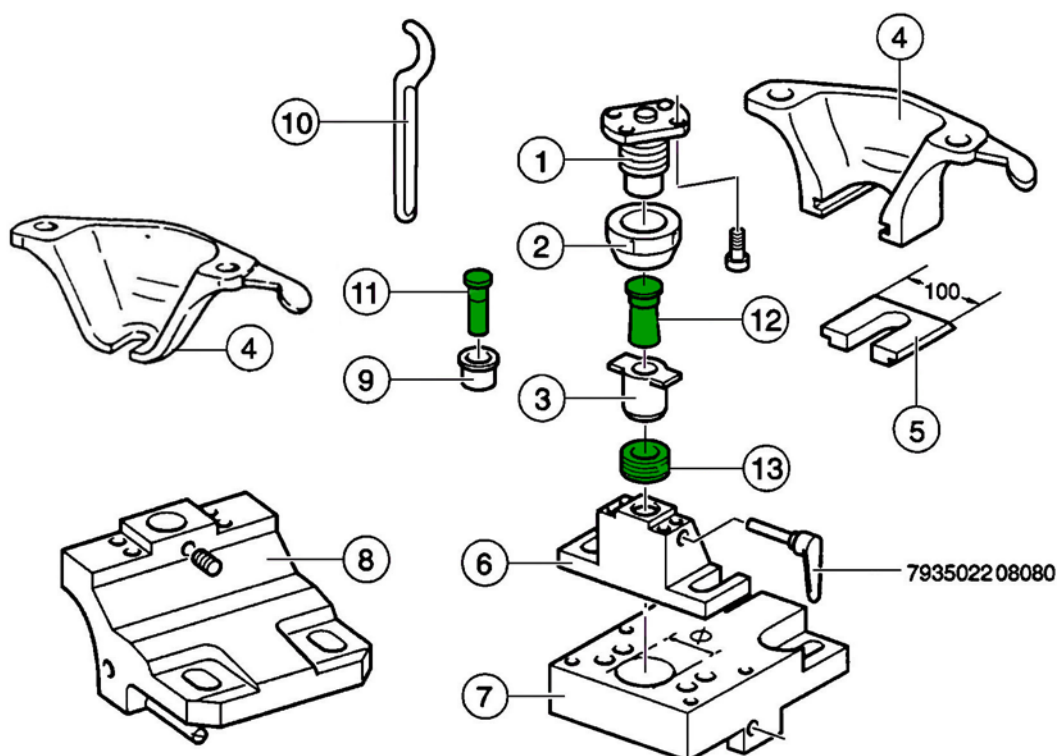

Punzones y matrices para el dispositivo de cambio rápido de punzonado



# Peddinghaus

Peddinghaus Anlagen & Maschinen GmbH

Peddinghaus Española, S.A.  
 Pol. Ind. Gojain  
 01170 Legutiano - Alava - España  
 tel. +34 945 46 53 70  
 fax +34 945 46 55 26  
 pesa@peddinghaus.es • www.peddy.de

## Série verde

| punzón redondo |               | punzón redondo |               | matriz redonda |               | matriz redonda |               | matriz redonda descentrada |               |
|----------------|---------------|----------------|---------------|----------------|---------------|----------------|---------------|----------------------------|---------------|
| No 2           |               | No 5           |               | No 3           |               | No 3           |               | No 14                      |               |
|                |               |                |               |                |               |                |               |                            |               |
|                | N° referencia |                | N° referencia |                | N° referencia |                | N° referencia |                            | N° referencia |
| 3,0            | 64002 1030    | 17,5           | 64005 1175    | 3,2            | 64203 1032    | 20,2           | 64203 1202    | 5,7                        | 64214 1057    |
| 3,2            | 64002 1032    | 18,0           | 64005 1180    | 3,4            | 64203 1034    | 20,7           | 64203 1207    | 6,2                        | 64214 1062    |
| 3,5            | 64002 1035    | 18,5           | 64005 1185    | 3,7            | 64203 1037    | 21,2           | 64203 1212    | 6,7                        | 64214 1067    |
| 4,0            | 64002 1040    | 19,0           | 64005 1190    | 4,2            | 64203 1042    | 21,7           | 64203 1217    | 7,2                        | 64214 1072    |
| 4,2            | 64002 1042    | 19,5           | 64005 1195    | 4,4            | 64203 1044    | 22,2           | 64203 1222    | 7,7                        | 64214 1077    |
| 4,5            | 64002 1045    | 20,0           | 64005 1200    | 4,7            | 64203 1047    | 22,7           | 64203 1227    | 8,2                        | 64214 1082    |
| 5,0            | 64002 1050    | 20,5           | 64005 1205    | 5,2            | 64203 1052    | 23,2           | 64203 1232    | 8,7                        | 64214 1087    |
| 5,5            | 64002 1055    | 21,0           | 64005 1210    | 5,7            | 64203 1057    | 23,7           | 64203 1237    | 9,2                        | 64214 1092    |
| 6,0            | 64002 1060    | 21,5           | 64005 1215    | 6,2            | 64203 1062    | 24,2           | 64203 1242    | 9,7                        | 64214 1097    |
| 6,5            | 64002 1065    | 22,0           | 64005 1220    | 6,7            | 64203 1067    | 24,7           | 64203 1247    | 10,2                       | 64214 1102    |
| 7,0            | 64002 1070    | 22,5           | 64005 1225    | 7,2            | 64203 1072    | 25,2           | 64203 1252    | 10,7                       | 64214 1107    |
| 7,5            | 64002 1075    | 23,0           | 64005 1230    | 7,7            | 64203 1077    | 25,7           | 64203 1257    | 11,2                       | 64214 1112    |
| 8,0            | 64002 1080    | 23,5           | 64005 1235    | 8,2            | 64203 1082    | 26,2           | 64203 1262    | 11,7                       | 64214 1117    |
| 8,5            | 64002 1085    | 24,0           | 64005 1240    | 8,7            | 64203 1087    | 26,7           | 64203 1267    | 12,2                       | 64214 1122    |
| 9,0            | 64002 1090    | 24,5           | 64005 1245    | 9,2            | 64203 1092    | 27,2           | 64203 1272    | 12,7                       | 64214 1127    |
| 9,5            | 64002 1095    | 25,0           | 64005 1250    | 9,7            | 64203 1097    | 27,7           | 64203 1277    | 13,2                       | 64214 1132    |
| 10,0           | 64002 1100    | 25,5           | 64005 1255    | 10,2           | 64203 1102    | 28,2           | 64203 1282    | 13,7                       | 64214 1137    |
| 10,5           | 64002 1105    | 26,0           | 64005 1260    | 10,7           | 64203 1107    | 28,7           | 64203 1287    | 14,2                       | 64214 1142    |
| 11,0           | 64002 1110    | 26,5           | 64005 1265    | 11,2           | 64203 1112    | 29,2           | 64203 1292    | 14,7                       | 64214 1147    |
| 11,5           | 64002 1115    | 27,0           | 64005 1270    | 11,7           | 64203 1117    | 29,7           | 64203 1297    | 15,2                       | 64214 1152    |
| 12,0           | 64002 1120    | 27,5           | 64005 1275    | 12,2           | 64203 1122    | 30,2           | 64203 1302    | 15,7                       | 64214 1157    |
| 12,5           | 64002 1125    | 28,0           | 64005 1280    | 12,7           | 64203 1127    | 30,7           | 64203 1307    | 16,2                       | 64214 1162    |
| 13,0           | 64002 1130    | 28,5           | 64005 1285    | 13,2           | 64203 1132    | 31,2           | 64203 1312    | 16,7                       | 64214 1167    |
| 13,5           | 64002 1135    | 29,0           | 64005 1290    | 13,7           | 64203 1137    | 31,7           | 64203 1317    | 17,2                       | 64214 1172    |
| 14,0           | 64002 1140    | 29,5           | 64005 1295    | 14,2           | 64203 1142    | 32,2           | 64203 1322    | 17,7                       | 64214 1177    |
| 14,5           | 64002 1145    | 30,0           | 64005 1300    | 14,7           | 64203 1147    | 32,7           | 64203 1327    | 18,2                       | 64214 1182    |
| 15,0           | 64002 1150    | 30,5           | 64005 1305    | 15,2           | 64203 1152    | 33,2           | 64203 1332    | 18,7                       | 64214 1187    |
| 15,5           | 64002 1155    | 31,0           | 64005 1310    | 15,7           | 64203 1157    |                |               | 19,2                       | 64214 1192    |
| 16,0           | 64002 1160    | 31,5           | 64005 1315    | 16,2           | 64203 1162    |                |               | 19,7                       | 64214 1197    |
| 16,5           | 64002 1165    | 32,0           | 64005 1320    | 16,7           | 64203 1167    |                |               | 20,2                       | 64214 1202    |
| 17,0           | 64002 1170    |                |               | 17,2           | 64203 1172    |                |               | 20,7                       | 64214 1207    |
| 17,5           | 64002 1175    |                |               | 17,7           | 64203 1177    |                |               | 21,2                       | 64214 1212    |
| 18,0           | 64002 1180    |                |               | 18,2           | 64203 1182    |                |               | 21,7                       | 64214 1217    |
| 18,5           | 64002 1185    |                |               | 18,7           | 64203 1187    |                |               | 22,2                       | 64214 1222    |
| 19,0           | 64002 1190    |                |               | 19,2           | 64203 1192    |                |               | 22,7                       | 64214 1227    |
|                |               |                |               | 19,7           | 64203 1197    |                |               | 23,2                       | 64214 1232    |
|                |               |                |               |                |               |                |               | 23,7                       | 64214 1237    |
|                |               |                |               |                |               |                |               | 24,2                       | 64214 1242    |
|                |               |                |               |                |               |                |               | 24,7                       | 64214 1247    |



manguito de reducción 2 / 5

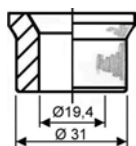

44081 198 503





# Peddinghaus

Peddinghaus Anlagen & Maschinen GmbH

Peddinghaus Española, S.A.  
 Pol. Ind. Gojain  
 01170 Legutiano - Alava - España  
 tel. +34 945 46 53 70  
 fax +34 945 46 55 26  
 pesa@peddinghaus.es • www.peddy.de

## Série verde

| punzón cuadrado |               | matriz cuadrada |               | punzón ovalado |                | matriz ovalada |                |
|-----------------|---------------|-----------------|---------------|----------------|----------------|----------------|----------------|
| No 2            |               | No 3            |               | No 2           |                | No 3           |                |
|                 |               |                 |               |                |                |                |                |
|                 | N° referencia |                 | N° referencia |                | N° referencia  |                | N° referencia  |
| 4,0             | 64002 2040    | 4,2             | 64203 2042    | 5,0 × 10,0     | 64002 3 050100 | 5,2 × 10,2     | 64203 3 052102 |
| 5,0             | 64002 2050    | 5,2             | 64203 2052    |                |                | 5,7 × 10,7     | 64203 3 057107 |
| 6,0             | 64002 2060    | 6,2             | 64203 2062    | 5,0 × 14,0     | 64002 3 050140 | 5,2 × 14,2     | 64203 3 052142 |
| 7,0             | 64002 2070    | 6,7             | 64203 2067    |                |                | 5,7 × 14,7     | 64203 3 057147 |
| 8,0             | 64002 2080    | 7,2             | 64203 2072    | 5,5 × 10,0     | 64002 3 055100 | 5,7 × 10,2     | 64203 3 057102 |
| 9,0             | 64002 2090    | 7,7             | 64203 2077    |                |                | 6,2 × 10,7     | 64203 3 062107 |
| 10,0            | 64002 2100    | 8,2             | 64203 2082    | 5,5 × 14,0     | 64002 3 055140 | 5,7 × 14,2     | 64203 3 057142 |
| 11,0            | 64002 2110    | 8,7             | 64203 2087    |                |                | 6,2 × 14,7     | 64203 3 062147 |
| 12,0            | 64002 2120    | 9,2             | 64203 2092    | 5,5 × 19,0     | 64002 3 055190 | 5,7 × 19,2     | 64203 3 057192 |
| 13,0            | 64002 2130    | 9,7             | 64203 2097    |                |                | 6,2 × 19,7     | 64203 3 062197 |
|                 |               | 10,2            | 64203 2102    | 6,5 × 12,0     | 64002 3 065120 | 6,7 × 12,2     | 64203 3 067122 |
|                 |               | 10,7            | 64203 2107    |                |                | 7,2 × 12,7     | 64203 3 072127 |
|                 |               | 11,2            | 64203 2112    | 6,5 × 18,0     | 64002 3 065180 | 6,7 × 18,2     | 64203 3 067182 |
|                 |               | 11,7            | 64203 2117    |                |                | 7,2 × 18,7     | 64203 3 072187 |
|                 |               | 12,2            | 64203 2122    | 7,5 × 14,0     | 64002 3 075140 | 7,7 × 14,2     | 64203 3 077142 |
|                 |               | 12,7            | 64203 2127    |                |                | 8,2 × 14,7     | 64203 3 082147 |
|                 |               | 13,2            | 64203 2132    | 9,0 × 14,0     | 64002 3 090140 | 9,2 × 14,2     | 64203 3 092142 |
|                 |               | 13,7            | 64203 2137    |                |                | 9,7 × 14,7     | 64203 3 097147 |
|                 |               | 14,2            | 64203 2142    | 9,0 × 18,0     | 64002 3 090180 | 9,2 × 18,2     | 64203 3 092182 |
|                 |               | 14,7            | 64203 2147    |                |                | 9,7 × 18,7     | 64203 3 097187 |
|                 |               | 15,2            | 64203 2152    | 10,0 × 14,0    | 64002 3 100140 | 10,2 × 14,2    | 64203 3 102142 |
|                 |               | 15,7            | 64203 2157    |                |                | 10,7 × 14,7    | 64203 3 107147 |
|                 |               | 16,2            | 64203 2162    |                |                | 11,2 × 15,2    | 64203 3 112152 |
|                 |               | 16,7            | 64203 2167    |                |                |                |                |
|                 |               | 17,2            | 64203 2172    |                |                |                |                |
|                 |               | 17,7            | 64203 2177    |                |                |                |                |
|                 |               | 18,2            | 64203 2182    |                |                |                |                |
|                 |               | 18,7            | 64203 2187    |                |                |                |                |
|                 |               | 19,2            | 64203 2192    |                |                |                |                |
|                 |               | 19,7            | 64203 2197    |                |                |                |                |
|                 |               | 20,2            | 64203 2202    |                |                |                |                |
|                 |               | 20,7            | 64203 2207    |                |                |                |                |
|                 |               | 21,2            | 64203 2212    |                |                |                |                |
|                 |               | 21,7            | 64203 2217    |                |                |                |                |
|                 |               | 22,2            | 64203 2222    |                |                |                |                |
|                 |               | 22,7            | 64203 2227    |                |                |                |                |
|                 |               | 23,2            | 64203 2232    |                |                |                |                |
|                 |               | 23,7            | 64203 2237    |                |                |                |                |

### punzón cuadrado

#### No 5

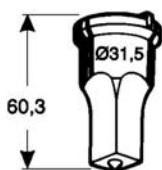

N° referencia

|      |            |
|------|------------|
| 14,0 | 64005 2140 |
| 15,0 | 64005 2150 |
| 16,0 | 64005 2160 |
| 17,0 | 64005 2170 |
| 18,0 | 64005 2180 |
| 19,0 | 64005 2190 |
| 20,0 | 64005 2200 |
| 21,0 | 64005 2210 |
| 22,0 | 64005 2220 |

| grosor del material | holgura |
|---------------------|---------|
| hasta 4 mm          | 0,2 mm  |
| 4 – 9 mm            | 0,7 mm  |
| 9 – 14 mm           | 1,2 mm  |



# Peddinghaus

Peddinghaus Anlagen & Maschinen GmbH

Peddinghaus Española, S.A.  
 Pol. Ind. Gojain  
 01170 Legutiano - Alava - España  
 tel. +34 945 46 53 70  
 fax +34 945 46 55 26  
 pesa@peddinghaus.es • www.peddy.de

## Série verde

| punzón ovalado     |                | matriz ovalada   |  | punzón ovalado     |                | matriz ovalada   |  |
|--------------------|----------------|--|--|--------------------|----------------|--|--|
| No 5               |                | No 3   |  | No 5               |                | No 3   |  |
|                    |                |  |  |                    |                |  |  |
| N° referencia      |                | N° referencia  |  | N° referencia      |                | N° referencia  |  |
| <b>5,5 × 25,0</b>  | 64005 3 055250 | <b>5,7 × 25,2</b><br><b>6,2 × 25,7</b>                         | 64203 3 057252<br>64203 3 062257                   | <b>12,0 × 24,0</b> | 64005 3 120240 | <b>12,2 × 24,2</b><br><b>12,7 × 24,7</b><br><b>13,2 × 25,2</b> | 64203 3 122242<br>64203 3 127247<br>64203 3 132252 |
| <b>6,5 × 26,0</b>  | 64005 3 065260 | <b>6,7 × 26,2</b><br><b>7,2 × 26,7</b>                         | 64203 3 067262<br>64203 3 072267                   | <b>12,0 × 30,0</b> | 64005 3 120300 | <b>12,2 × 30,2</b><br><b>12,7 × 30,7</b><br><b>13,2 × 31,2</b> | 64203 3 122302<br>64203 3 127307<br>64203 3 132312 |
| <b>6,5 × 30,0</b>  | 64005 3 065300 | <b>6,7 × 30,2</b><br><b>7,2 × 30,7</b>                         | 64203 3 067302<br>64203 3 072307                   | <b>13,0 × 26,0</b> | 64005 3 130260 | <b>13,2 × 26,2</b><br><b>13,7 × 26,7</b><br><b>14,2 × 27,2</b> | 64203 3 132262<br>64203 3 137267<br>64203 3 142272 |
| <b>7,5 × 21,0</b>  | 64005 3 075210 | <b>7,7 × 21,2</b><br><b>8,2 × 21,7</b>                         | 64203 3 077212<br>64203 3 082217                   | <b>13,0 × 30,0</b> | 64005 3 130300 | <b>13,2 × 30,2</b><br><b>13,7 × 30,7</b><br><b>14,2 × 31,2</b> | 64203 3 132302<br>64203 3 137307<br>64203 3 142312 |
| <b>7,5 × 26,0</b>  | 64005 3 075260 | <b>7,7 × 26,2</b><br><b>8,2 × 26,7</b>                         | 64203 3 077262<br>64203 3 082267                   | <b>14,0 × 26,0</b> | 64005 3 140260 | <b>14,2 × 26,2</b><br><b>14,7 × 26,7</b><br><b>15,2 × 27,2</b> | 64203 3 142262<br>64203 3 147267<br>64203 3 152272 |
| <b>7,5 × 30,0</b>  | 64005 3 075300 | <b>7,7 × 30,2</b><br><b>8,2 × 30,7</b>                         | 64203 3 077302<br>64203 3 082307                   | <b>14,0 × 28,0</b> | 64005 3 140280 | <b>14,2 × 28,2</b><br><b>14,7 × 28,7</b><br><b>15,2 × 29,2</b> | 64203 3 142282<br>64203 3 147287<br>64203 3 152292 |
| <b>9,0 × 26,0</b>  | 64005 3 090260 | <b>9,2 × 26,2</b><br><b>9,7 × 26,7</b>                         | 64203 3 092262<br>64203 3 097267                   | <b>16,0 × 26,0</b> | 64005 3 160260 | <b>16,2 × 26,2</b><br><b>16,7 × 26,7</b><br><b>17,2 × 27,2</b> | 64203 3 162262<br>64203 3 167267<br>64203 3 172272 |
| <b>9,0 × 30,0</b>  | 64005 3 090300 | <b>9,2 × 30,2</b><br><b>9,7 × 30,7</b>                         | 64203 3 092302<br>64203 3 097307                   | <b>16,0 × 31,0</b> | 64005 3 160310 | <b>16,2 × 31,2</b><br><b>16,7 × 31,7</b><br><b>17,2 × 32,2</b> | 64203 3 162312<br>64203 3 167317<br>64203 3 172322 |
| <b>10,0 × 20,0</b> | 64005 3 100200 | <b>10,2 × 20,2</b><br><b>10,7 × 20,7</b><br><b>11,2 × 21,2</b> | 64203 3 102202<br>64203 3 107207<br>64203 3 112212 | <b>18,0 × 26,0</b> | 64005 3 180260 | <b>18,2 × 26,2</b><br><b>18,7 × 26,7</b><br><b>19,2 × 27,2</b> | 64203 3 182262<br>64203 3 187267<br>64203 3 192272 |
| <b>10,0 × 26,0</b> | 64005 3 100260 | <b>10,2 × 26,2</b><br><b>10,7 × 26,7</b><br><b>11,2 × 27,2</b> | 64203 3 102262<br>64203 3 107267<br>64203 3 112272 | <b>18,0 × 31,0</b> | 64005 3 180310 | <b>18,2 × 31,2</b><br><b>18,7 × 31,7</b><br><b>19,2 × 32,2</b> | 64203 3 182312<br>64203 3 187317<br>64203 3 192322 |
| <b>10,0 × 30,0</b> | 64005 3 100300 | <b>10,2 × 30,2</b><br><b>10,7 × 30,7</b><br><b>11,2 × 31,2</b> | 64203 3 102302<br>64203 3 107307<br>64203 3 112312 | <b>20,0 × 31,0</b> | 64005 3 200310 | <b>20,2 × 31,2</b><br><b>20,7 × 31,7</b><br><b>21,2 × 32,2</b> | 64203 3 202312<br>64203 3 207317<br>64203 3 212322 |
| <b>11,0 × 22,0</b> | 64005 3 110220 | <b>11,2 × 22,2</b><br><b>11,7 × 22,7</b><br><b>12,2 × 23,2</b> | 64203 3 112222<br>64203 3 117227<br>64203 3 122232 | <b>22,0 × 31,0</b> | 64005 3 220310 | <b>22,2 × 31,2</b><br><b>22,7 × 31,7</b><br><b>23,2 × 32,2</b> | 64203 3 222312<br>64203 3 227317<br>64203 3 232322 |
| <b>11,0 × 26,0</b> | 64005 3 110260 | <b>11,2 × 26,2</b><br><b>11,7 × 26,7</b><br><b>12,2 × 27,2</b> | 64203 3 112262<br>64203 3 117267<br>64203 3 122272 |                    |                |  |  |
| <b>11,0 × 30,0</b> | 64005 3 110300 | <b>11,2 × 30,2</b><br><b>11,7 × 30,7</b><br><b>12,2 × 31,2</b> | 64203 3 112302<br>64203 3 117307<br>64203 3 122312 |                    |                |  |  |

holgura: **0,2 mm** (grosor del material hasta 4 mm) • **0,7 mm** (grosor del material 4 – 9 mm) • **1,2 mm** (grosor del material 9 – 14 mm)



# Peddinghaus

Peddinghaus Anlagen & Maschinen GmbH

Peddinghaus Española, S.A.  
 Pol. Ind. Gojain  
 01170 Legutiano - Alava - España  
 tel. +34 945 46 53 70  
 fax +34 945 46 55 26  
 pesa@peddinghaus.es • www.peddy.de

## Série verde









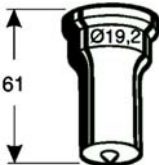
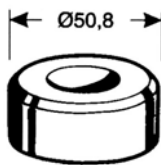
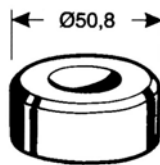
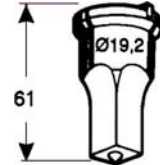

| punzón ovalado                   | punzón ovalado                    | matriz ovalada descentrada, longitudinal | matriz ovalada descentrada, transversal |
|----------------------------------|-----------------------------------|--|---|
| No 2                             | No 5                              | No 14                                    | No 14                                   |
|                                  |                                   |  |   |
| N° referencia                    | N° referencia                     | N° referencia                            | N° referencia                           |
| <b>5,5 × 14,0</b> 64002 3 055140 | <b>5,5 × 25,0</b> 64005 3 055250  | <b>6,2 × 14,7</b> 64214 3 062147         | <b>6,2 × 14,7</b> 64214 4 062147        |
|                                  | <b>6,5 × 26,0</b> 64005 3 065260  | <b>6,2 × 25,7</b> 64214 3 062257         | <b>6,2 × 25,7</b> 64214 4 062257        |
|                                  | <b>7,5 × 26,0</b> 64005 3 075260  | <b>7,2 × 26,7</b> 64214 3 072267         | <b>7,2 × 26,7</b> 64214 4 072267        |
|                                  |                                   | <b>8,2 × 26,7</b> 64214 3 082267         | <b>8,2 × 26,7</b> 64214 4 082267        |
| <b>9,0 × 14,0</b> 64002 3 090140 |                                   | <b>9,7 × 14,7</b> 64214 3 097147         | <b>9,7 × 14,7</b> 64214 4 097147        |
|                                  | <b>9,0 × 26,0</b> 64005 3 090260  | <b>9,7 × 26,7</b> 64214 3 097267         | <b>9,7 × 26,7</b> 64214 4 097267        |
|                                  | <b>10,0 × 20,0</b> 64005 3 100200 | <b>10,7 × 20,7</b> 64214 3 107207        | <b>10,7 × 20,7</b> 64214 4 107207       |
|                                  | <b>11,0 × 22,0</b> 64005 3 110220 | <b>11,7 × 22,7</b> 64214 3 117227        | <b>11,7 × 22,7</b> 64214 4 117227       |
|                                  | <b>11,0 × 26,0</b> 64005 3 110260 | <b>11,7 × 26,7</b> 64214 3 117267        | <b>11,7 × 26,7</b> 64214 4 117267       |
|                                  | <b>13,0 × 26,0</b> 64005 3 130260 | <b>13,7 × 26,7</b> 64214 3 137267        | <b>13,7 × 26,7</b> 64214 4 137267       |
|                                  | <b>14,0 × 26,0</b> 64005 3 140260 | <b>14,7 × 26,7</b> 64214 3 147267        | <b>14,7 × 26,7</b> 64214 4 147267       |
|                                  | <b>16,0 × 26,0</b> 64005 3 160260 | <b>16,7 × 26,7</b> 64214 3 167267        | <b>16,7 × 26,7</b> 64214 4 167267       |

## Série verde

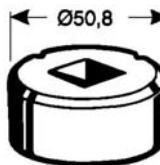
| punzón rectangular           |                | matriz rectangular           |                | punzón para cerradura*               |                 | matriz para cerradura                |                   |
|------------------------------|----------------|------------------------------|----------------|--------------------------------------|-----------------|--------------------------------------|-------------------|
| No 5                         |                | No 3                         |                | No 5                                 |                 | No 3                                 |                   |
|                              |                |                              |                |                                      |                 |                                      |                   |
|                              | N° referencia  |                              | N° referencia  |                                      | N° referencia   |                                      | N° referencia     |
| 5,0 × 15                     | 64005 5 050150 | 5,2 × 15,2                   | 64203 5 052152 | 34,0 × Ø17,5 × 10,5                  | 65005 17001     | 34,2 × Ø17,7 × 10,7                  | 65203 17001       |
| 5,0 × 20                     | 64005 5 050200 | 5,7 × 15,7                   | 64203 5 057157 |                                      |                 |                                      |                   |
| 5,0 × 20                     | 64005 5 050200 | 5,2 × 20,2                   | 64203 5 052202 | *adicionalmente es necesario:        |                 |                                      |                   |
| 6,0 × 24                     | 64005 5 060240 | 5,7 × 20,7                   | 64203 5 057207 | tensor rápido, cerradura             |                 | para dispositivo de cambio rápido    |                   |
| 6,0 × 24                     | 64005 5 060240 | 6,2 × 24,2                   | 64203 5 062242 | de punzonado, serie verde,           |                 | suministrado desde 1993:             | 42217 6 2002 02   |
| 8,0 × 16                     | 64005 5 080160 | 6,7 × 24,7                   | 64203 5 067247 | hasta 1993:                          |                 | tensor rápido, cerradura             | P-44081 6 2005 01 |
| 8,0 × 16                     | 64005 5 080160 | 8,2 × 16,2                   | 64203 5 082162 |                                      |                 |                                      |                   |
| 8,0 × 24                     | 64005 5 080240 | 8,7 × 16,7                   | 64203 5 087167 |                                      |                 |                                      |                   |
| 8,0 × 24                     | 64005 5 080240 | 8,2 × 24,2                   | 64203 5 082242 |                                      |                 |                                      |                   |
| 9,0 × 24                     | 64005 5 090240 | 8,7 × 24,7                   | 64203 5 087247 |                                      |                 |                                      |                   |
| 9,0 × 24                     | 64005 5 090240 | 9,2 × 24,2                   | 64203 5 092242 |                                      |                 |                                      |                   |
| 10,0 × 20                    | 64005 5 100200 | 9,7 × 24,7                   | 64203 5 097247 |                                      |                 |                                      |                   |
| 10,0 × 20                    | 64005 5 100200 | 10,2 × 20,2                  | 64203 5 102202 |                                      |                 |                                      |                   |
| 11,0 × 22                    | 64005 5 110220 | 10,7 × 20,7                  | 64203 5 107207 |                                      |                 |                                      |                   |
| 11,0 × 22                    | 64005 5 110220 | 11,2 × 22,2                  | 64203 5 112222 |                                      |                 |                                      |                   |
| 12,0 × 22                    | 64005 5 120220 | 11,7 × 22,7                  | 64203 5 117227 |                                      |                 |                                      |                   |
| 12,0 × 22                    | 64005 5 120220 | 12,2 × 22,2                  | 64203 5 122222 |                                      |                 |                                      |                   |
| 12,0 × 30                    | 64005 5 120300 | 12,7 × 22,7                  | 64203 5 127227 |                                      |                 |                                      |                   |
| 12,0 × 30                    | 64005 5 120300 | 12,2 × 30,2                  | 64203 5 122302 |                                      |                 |                                      |                   |
| 14,0 × 20                    | 64005 5 140200 | 12,7 × 30,7                  | 64203 5 127307 |                                      |                 |                                      |                   |
| 14,0 × 20                    | 64005 5 140200 | 14,2 × 20,2                  | 64203 5 142202 |                                      |                 |                                      |                   |
| 16,0 × 20                    | 64005 5 160200 | 14,7 × 20,7                  | 64203 5 147207 |                                      |                 |                                      |                   |
| 16,0 × 20                    | 64005 5 160200 | 16,2 × 20,2                  | 64203 5 162202 |                                      |                 |                                      |                   |
| 16,0 × 20                    | 64005 5 160200 | 16,7 × 20,7                  | 64203 5 167207 |                                      |                 |                                      |                   |
| punzón de esquina redondeada |                | matriz de esquina redondeada |                | punzón cuadrado c/bordes redondeados |                 | matriz cuadrada c/bordes redondeados |                   |
| No 5                         |                | No 3                         |                | No 5                                 |                 | No 3                                 |                   |
|                              |                |                              |                |                                      |                 |                                      |                   |
|                              | N° referencia  |                              | N° referencia  |                                      | N° referencia   |                                      | N° referencia     |
| radio                        |                | radio                        |                | Ø 22,2 × 20,3                        | 65005 38 222203 | Ø 22,4 × 20,5                        | 65203 38 224205   |
| 5                            | 65005 37 00050 | 5                            | 65203 37 00050 |                                      |                 |                                      |                   |
| 10                           | 65005 37 00100 | 10                           | 65203 37 00100 |                                      |                 |                                      |                   |
| 15                           | 65005 37 00150 | 14                           | 65203 37 00140 |                                      |                 |                                      |                   |
|                              |                | 15                           | 65203 37 00150 |                                      |                 |                                      |                   |

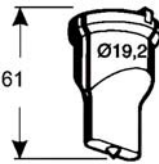
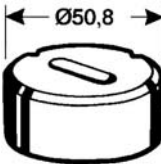
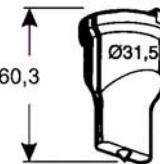
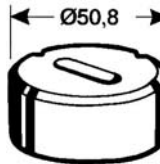
## Série verde

Punzones especiales  
 para punzonado de acero inoxidable

| punzón redondo especial   | matriz redonda (estándar)   | matriz redonda (estándar)   | punzón cuadrado especial  |                  |   |                  |                |                  |                |   |             |                  |             |                  |             |                  |   |                  |                |                  |                |                  |                |                  |                |                  |                |                  |                |                  |      |                  |      |                  |      |                  |   |     |            |     |            |     |            |     |            |     |            |     |            |     |            |     |            |     |            |     |            |     |            |     |            |     |            |     |            |      |            |      |            |      |            |      |            |   |      |            |      |            |      |            |      |            |      |            |      |            |      |            |      |            |      |            |      |            |      |            |      |            |      |            |  |     |                  |     |            |
|---|---|---|---|------------------|---|------------------|----------------|------------------|----------------|---|-------------|------------------|-------------|------------------|-------------|------------------|---|------------------|----------------|------------------|----------------|------------------|----------------|------------------|----------------|------------------|----------------|------------------|----------------|------------------|------|------------------|------|------------------|------|------------------|---|-----|------------|-----|------------|-----|------------|-----|------------|-----|------------|-----|------------|-----|------------|-----|------------|-----|------------|-----|------------|-----|------------|-----|------------|-----|------------|-----|------------|------|------------|------|------------|------|------------|------|------------|---|------|------------|------|------------|------|------------|------|------------|------|------------|------|------------|------|------------|------|------------|------|------------|------|------------|------|------------|------|------------|------|------------|--|-----|------------------|-----|------------|
| <b>No 2</b>   | <b>No 3</b>   | <b>No 3</b>   | <b>No 2</b>   |                  |   |                  |                |                  |                |   |             |                  |             |                  |             |                  |   |                  |                |                  |                |                  |                |                  |                |                  |                |                  |                |                  |      |                  |      |                  |      |                  |   |     |            |     |            |     |            |     |            |     |            |     |            |     |            |     |            |     |            |     |            |     |            |     |            |     |            |     |            |      |            |      |            |      |            |      |            |   |      |            |      |            |      |            |      |            |      |            |      |            |      |            |      |            |      |            |      |            |      |            |      |            |      |            |  |     |                  |     |            |
|    |                  |                 |                  |                  |   |                  |                |                  |                |   |             |                  |             |                  |             |                  |   |                  |                |                  |                |                  |                |                  |                |                  |                |                  |                |                  |      |                  |      |                  |      |                  |   |     |            |     |            |     |            |     |            |     |            |     |            |     |            |     |            |     |            |     |            |     |            |     |            |     |            |     |            |      |            |      |            |      |            |      |            |   |      |            |      |            |      |            |      |            |      |            |      |            |      |            |      |            |      |            |      |            |      |            |      |            |      |            |  |     |                  |     |            |
|  N° referencia   |  N° referencia   |  N° referencia   |  N° referencia   |                  |   |                  |                |                  |                |   |             |                  |             |                  |             |                  |   |                  |                |                  |                |                  |                |                  |                |                  |                |                  |                |                  |      |                  |      |                  |      |                  |   |     |            |     |            |     |            |     |            |     |            |     |            |     |            |     |            |     |            |     |            |     |            |     |            |     |            |     |            |      |            |      |            |      |            |      |            |   |      |            |      |            |      |            |      |            |      |            |      |            |      |            |      |            |      |            |      |            |      |            |      |            |      |            |  |     |                  |     |            |
| <table border="0"> <tr><td>3,0</td><td>P-65002 8012 030</td></tr> <tr><td>4,0</td><td>P-65002 8012 040</td></tr> <tr><td>4,5</td><td>P-65002 8012 045</td></tr> <tr><td>5,0</td><td>P-65002 8012 050</td></tr> <tr><td>5,5</td><td>P-65002 8012 055</td></tr> <tr><td>6,0</td><td>P-65002 8012 060</td></tr> <tr><td>6,5</td><td>P-65002 8012 065</td></tr> <tr><td>7,0</td><td>P-65002 8012 070</td></tr> <tr><td>8,0</td><td>P-65002 8012 080</td></tr> <tr><td>9,0</td><td>P-65002 8012 090</td></tr> <tr><td>10,0</td><td>P-65002 8012 100</td></tr> <tr><td>11,0</td><td>P-65002 8012 110</td></tr> <tr><td>12,0</td><td>P-65002 8012 120</td></tr> <tr><td>13,0</td><td>P-65002 8012 130</td></tr> <tr><td>14,0</td><td>P-65002 8012 140</td></tr> <tr><td>15,0</td><td>P-65002 8012 150</td></tr> <tr><td>16,0</td><td>P-65002 8012 160</td></tr> <tr><td>17,0</td><td>P-65002 8012 170</td></tr> </table> | 3,0   | P-65002 8012 030  | 4,0   | P-65002 8012 040 | 4,5   | P-65002 8012 045 | 5,0            | P-65002 8012 050 | 5,5            | P-65002 8012 055  | 6,0         | P-65002 8012 060 | 6,5         | P-65002 8012 065 | 7,0         | P-65002 8012 070 | 8,0   | P-65002 8012 080 | 9,0            | P-65002 8012 090 | 10,0           | P-65002 8012 100 | 11,0           | P-65002 8012 110 | 12,0           | P-65002 8012 120 | 13,0           | P-65002 8012 130 | 14,0           | P-65002 8012 140 | 15,0 | P-65002 8012 150 | 16,0 | P-65002 8012 160 | 17,0 | P-65002 8012 170 | <table border="0"> <tr><td>3,2</td><td>64203 1032</td></tr> <tr><td>3,7</td><td>64203 1037</td></tr> <tr><td>4,2</td><td>64203 1042</td></tr> <tr><td>4,7</td><td>64203 1047</td></tr> <tr><td>5,2</td><td>64203 1052</td></tr> <tr><td>5,7</td><td>64203 1057</td></tr> <tr><td>6,2</td><td>64203 1062</td></tr> <tr><td>6,7</td><td>64203 1067</td></tr> <tr><td>7,2</td><td>64203 1072</td></tr> <tr><td>7,7</td><td>64203 1077</td></tr> <tr><td>8,2</td><td>64203 1082</td></tr> <tr><td>8,7</td><td>64203 1087</td></tr> <tr><td>9,2</td><td>64203 1092</td></tr> <tr><td>9,7</td><td>64203 1097</td></tr> <tr><td>10,2</td><td>64203 1102</td></tr> <tr><td>10,7</td><td>64203 1107</td></tr> <tr><td>11,2</td><td>64203 1112</td></tr> <tr><td>11,7</td><td>64203 1117</td></tr> </table> | 3,2 | 64203 1032 | 3,7 | 64203 1037 | 4,2 | 64203 1042 | 4,7 | 64203 1047 | 5,2 | 64203 1052 | 5,7 | 64203 1057 | 6,2 | 64203 1062 | 6,7 | 64203 1067 | 7,2 | 64203 1072 | 7,7 | 64203 1077 | 8,2 | 64203 1082 | 8,7 | 64203 1087 | 9,2 | 64203 1092 | 9,7 | 64203 1097 | 10,2 | 64203 1102 | 10,7 | 64203 1107 | 11,2 | 64203 1112 | 11,7 | 64203 1117 | <table border="0"> <tr><td>12,2</td><td>64203 1122</td></tr> <tr><td>12,7</td><td>64203 1127</td></tr> <tr><td>13,2</td><td>64203 1132</td></tr> <tr><td>13,7</td><td>64203 1137</td></tr> <tr><td>14,2</td><td>64203 1142</td></tr> <tr><td>14,7</td><td>64203 1147</td></tr> <tr><td>15,2</td><td>64203 1152</td></tr> <tr><td>15,7</td><td>64203 1157</td></tr> <tr><td>16,2</td><td>64203 1162</td></tr> <tr><td>16,7</td><td>64203 1167</td></tr> <tr><td>17,2</td><td>64203 1172</td></tr> <tr><td>17,7</td><td>64203 1177</td></tr> <tr><td>18,2</td><td>64203 1182</td></tr> </table> | 12,2 | 64203 1122 | 12,7 | 64203 1127 | 13,2 | 64203 1132 | 13,7 | 64203 1137 | 14,2 | 64203 1142 | 14,7 | 64203 1147 | 15,2 | 64203 1152 | 15,7 | 64203 1157 | 16,2 | 64203 1162 | 16,7 | 64203 1167 | 17,2 | 64203 1172 | 17,7 | 64203 1177 | 18,2 | 64203 1182 | <table border="0"> <tr><td>9,0</td><td>P-65002 8014 090</td></tr> </table> <p><b>matriz cuadrada (estándar)</b></p> <p><b>No 3</b></p>  <p> N° referencia</p> <table border="0"> <tr><td>9,7</td><td>64203 2097</td></tr> </table> | 9,0 | P-65002 8014 090 | 9,7 | 64203 2097 |
| 3,0   | P-65002 8012 030  |   |   |                  |   |                  |                |                  |                |   |             |                  |             |                  |             |                  |   |                  |                |                  |                |                  |                |                  |                |                  |                |                  |                |                  |      |                  |      |                  |      |                  |   |     |            |     |            |     |            |     |            |     |            |     |            |     |            |     |            |     |            |     |            |     |            |     |            |     |            |     |            |      |            |      |            |      |            |      |            |   |      |            |      |            |      |            |      |            |      |            |      |            |      |            |      |            |      |            |      |            |      |            |      |            |      |            |  |     |                  |     |            |
| 4,0   | P-65002 8012 040  |   |   |                  |   |                  |                |                  |                |   |             |                  |             |                  |             |                  |   |                  |                |                  |                |                  |                |                  |                |                  |                |                  |                |                  |      |                  |      |                  |      |                  |   |     |            |     |            |     |            |     |            |     |            |     |            |     |            |     |            |     |            |     |            |     |            |     |            |     |            |     |            |      |            |      |            |      |            |      |            |   |      |            |      |            |      |            |      |            |      |            |      |            |      |            |      |            |      |            |      |            |      |            |      |            |      |            |  |     |                  |     |            |
| 4,5   | P-65002 8012 045  |   |   |                  |   |                  |                |                  |                |   |             |                  |             |                  |             |                  |   |                  |                |                  |                |                  |                |                  |                |                  |                |                  |                |                  |      |                  |      |                  |      |                  |   |     |            |     |            |     |            |     |            |     |            |     |            |     |            |     |            |     |            |     |            |     |            |     |            |     |            |     |            |      |            |      |            |      |            |      |            |   |      |            |      |            |      |            |      |            |      |            |      |            |      |            |      |            |      |            |      |            |      |            |      |            |      |            |  |     |                  |     |            |
| 5,0   | P-65002 8012 050  |   |   |                  |   |                  |                |                  |                |   |             |                  |             |                  |             |                  |   |                  |                |                  |                |                  |                |                  |                |                  |                |                  |                |                  |      |                  |      |                  |      |                  |   |     |            |     |            |     |            |     |            |     |            |     |            |     |            |     |            |     |            |     |            |     |            |     |            |     |            |     |            |      |            |      |            |      |            |      |            |   |      |            |      |            |      |            |      |            |      |            |      |            |      |            |      |            |      |            |      |            |      |            |      |            |      |            |  |     |                  |     |            |
| 5,5   | P-65002 8012 055  |   |   |                  |   |                  |                |                  |                |   |             |                  |             |                  |             |                  |   |                  |                |                  |                |                  |                |                  |                |                  |                |                  |                |                  |      |                  |      |                  |      |                  |   |     |            |     |            |     |            |     |            |     |            |     |            |     |            |     |            |     |            |     |            |     |            |     |            |     |            |     |            |      |            |      |            |      |            |      |            |   |      |            |      |            |      |            |      |            |      |            |      |            |      |            |      |            |      |            |      |            |      |            |      |            |      |            |  |     |                  |     |            |
| 6,0   | P-65002 8012 060  |   |   |                  |   |                  |                |                  |                |   |             |                  |             |                  |             |                  |   |                  |                |                  |                |                  |                |                  |                |                  |                |                  |                |                  |      |                  |      |                  |      |                  |   |     |            |     |            |     |            |     |            |     |            |     |            |     |            |     |            |     |            |     |            |     |            |     |            |     |            |     |            |      |            |      |            |      |            |      |            |   |      |            |      |            |      |            |      |            |      |            |      |            |      |            |      |            |      |            |      |            |      |            |      |            |      |            |  |     |                  |     |            |
| 6,5   | P-65002 8012 065  |   |   |                  |   |                  |                |                  |                |   |             |                  |             |                  |             |                  |   |                  |                |                  |                |                  |                |                  |                |                  |                |                  |                |                  |      |                  |      |                  |      |                  |   |     |            |     |            |     |            |     |            |     |            |     |            |     |            |     |            |     |            |     |            |     |            |     |            |     |            |     |            |      |            |      |            |      |            |      |            |   |      |            |      |            |      |            |      |            |      |            |      |            |      |            |      |            |      |            |      |            |      |            |      |            |      |            |  |     |                  |     |            |
| 7,0   | P-65002 8012 070  |   |   |                  |   |                  |                |                  |                |   |             |                  |             |                  |             |                  |   |                  |                |                  |                |                  |                |                  |                |                  |                |                  |                |                  |      |                  |      |                  |      |                  |   |     |            |     |            |     |            |     |            |     |            |     |            |     |            |     |            |     |            |     |            |     |            |     |            |     |            |     |            |      |            |      |            |      |            |      |            |   |      |            |      |            |      |            |      |            |      |            |      |            |      |            |      |            |      |            |      |            |      |            |      |            |      |            |  |     |                  |     |            |
| 8,0   | P-65002 8012 080  |   |   |                  |   |                  |                |                  |                |   |             |                  |             |                  |             |                  |   |                  |                |                  |                |                  |                |                  |                |                  |                |                  |                |                  |      |                  |      |                  |      |                  |   |     |            |     |            |     |            |     |            |     |            |     |            |     |            |     |            |     |            |     |            |     |            |     |            |     |            |     |            |      |            |      |            |      |            |      |            |   |      |            |      |            |      |            |      |            |      |            |      |            |      |            |      |            |      |            |      |            |      |            |      |            |      |            |  |     |                  |     |            |
| 9,0   | P-65002 8012 090  |   |   |                  |   |                  |                |                  |                |   |             |                  |             |                  |             |                  |   |                  |                |                  |                |                  |                |                  |                |                  |                |                  |                |                  |      |                  |      |                  |      |                  |   |     |            |     |            |     |            |     |            |     |            |     |            |     |            |     |            |     |            |     |            |     |            |     |            |     |            |     |            |      |            |      |            |      |            |      |            |   |      |            |      |            |      |            |      |            |      |            |      |            |      |            |      |            |      |            |      |            |      |            |      |            |      |            |  |     |                  |     |            |
| 10,0  | P-65002 8012 100  |   |   |                  |   |                  |                |                  |                |   |             |                  |             |                  |             |                  |   |                  |                |                  |                |                  |                |                  |                |                  |                |                  |                |                  |      |                  |      |                  |      |                  |   |     |            |     |            |     |            |     |            |     |            |     |            |     |            |     |            |     |            |     |            |     |            |     |            |     |            |     |            |      |            |      |            |      |            |      |            |   |      |            |      |            |      |            |      |            |      |            |      |            |      |            |      |            |      |            |      |            |      |            |      |            |      |            |  |     |                  |     |            |
| 11,0  | P-65002 8012 110  |   |   |                  |   |                  |                |                  |                |   |             |                  |             |                  |             |                  |   |                  |                |                  |                |                  |                |                  |                |                  |                |                  |                |                  |      |                  |      |                  |      |                  |   |     |            |     |            |     |            |     |            |     |            |     |            |     |            |     |            |     |            |     |            |     |            |     |            |     |            |     |            |      |            |      |            |      |            |      |            |   |      |            |      |            |      |            |      |            |      |            |      |            |      |            |      |            |      |            |      |            |      |            |      |            |      |            |  |     |                  |     |            |
| 12,0  | P-65002 8012 120  |   |   |                  |   |                  |                |                  |                |   |             |                  |             |                  |             |                  |   |                  |                |                  |                |                  |                |                  |                |                  |                |                  |                |                  |      |                  |      |                  |      |                  |   |     |            |     |            |     |            |     |            |     |            |     |            |     |            |     |            |     |            |     |            |     |            |     |            |     |            |     |            |      |            |      |            |      |            |      |            |   |      |            |      |            |      |            |      |            |      |            |      |            |      |            |      |            |      |            |      |            |      |            |      |            |      |            |  |     |                  |     |            |
| 13,0  | P-65002 8012 130  |   |   |                  |   |                  |                |                  |                |   |             |                  |             |                  |             |                  |   |                  |                |                  |                |                  |                |                  |                |                  |                |                  |                |                  |      |                  |      |                  |      |                  |   |     |            |     |            |     |            |     |            |     |            |     |            |     |            |     |            |     |            |     |            |     |            |     |            |     |            |     |            |      |            |      |            |      |            |      |            |   |      |            |      |            |      |            |      |            |      |            |      |            |      |            |      |            |      |            |      |            |      |            |      |            |      |            |  |     |                  |     |            |
| 14,0  | P-65002 8012 140  |   |   |                  |   |                  |                |                  |                |   |             |                  |             |                  |             |                  |   |                  |                |                  |                |                  |                |                  |                |                  |                |                  |                |                  |      |                  |      |                  |      |                  |   |     |            |     |            |     |            |     |            |     |            |     |            |     |            |     |            |     |            |     |            |     |            |     |            |     |            |     |            |      |            |      |            |      |            |      |            |   |      |            |      |            |      |            |      |            |      |            |      |            |      |            |      |            |      |            |      |            |      |            |      |            |      |            |  |     |                  |     |            |
| 15,0  | P-65002 8012 150  |   |   |                  |   |                  |                |                  |                |   |             |                  |             |                  |             |                  |   |                  |                |                  |                |                  |                |                  |                |                  |                |                  |                |                  |      |                  |      |                  |      |                  |   |     |            |     |            |     |            |     |            |     |            |     |            |     |            |     |            |     |            |     |            |     |            |     |            |     |            |     |            |      |            |      |            |      |            |      |            |   |      |            |      |            |      |            |      |            |      |            |      |            |      |            |      |            |      |            |      |            |      |            |      |            |      |            |  |     |                  |     |            |
| 16,0  | P-65002 8012 160  |   |   |                  |   |                  |                |                  |                |   |             |                  |             |                  |             |                  |   |                  |                |                  |                |                  |                |                  |                |                  |                |                  |                |                  |      |                  |      |                  |      |                  |   |     |            |     |            |     |            |     |            |     |            |     |            |     |            |     |            |     |            |     |            |     |            |     |            |     |            |     |            |      |            |      |            |      |            |      |            |   |      |            |      |            |      |            |      |            |      |            |      |            |      |            |      |            |      |            |      |            |      |            |      |            |      |            |  |     |                  |     |            |
| 17,0  | P-65002 8012 170  |   |   |                  |   |                  |                |                  |                |   |             |                  |             |                  |             |                  |   |                  |                |                  |                |                  |                |                  |                |                  |                |                  |                |                  |      |                  |      |                  |      |                  |   |     |            |     |            |     |            |     |            |     |            |     |            |     |            |     |            |     |            |     |            |     |            |     |            |     |            |     |            |      |            |      |            |      |            |      |            |   |      |            |      |            |      |            |      |            |      |            |      |            |      |            |      |            |      |            |      |            |      |            |      |            |      |            |  |     |                  |     |            |
| 3,2   | 64203 1032  |   |   |                  |   |                  |                |                  |                |   |             |                  |             |                  |             |                  |   |                  |                |                  |                |                  |                |                  |                |                  |                |                  |                |                  |      |                  |      |                  |      |                  |   |     |            |     |            |     |            |     |            |     |            |     |            |     |            |     |            |     |            |     |            |     |            |     |            |     |            |     |            |      |            |      |            |      |            |      |            |   |      |            |      |            |      |            |      |            |      |            |      |            |      |            |      |            |      |            |      |            |      |            |      |            |      |            |  |     |                  |     |            |
| 3,7   | 64203 1037  |   |   |                  |   |                  |                |                  |                |   |             |                  |             |                  |             |                  |   |                  |                |                  |                |                  |                |                  |                |                  |                |                  |                |                  |      |                  |      |                  |      |                  |   |     |            |     |            |     |            |     |            |     |            |     |            |     |            |     |            |     |            |     |            |     |            |     |            |     |            |     |            |      |            |      |            |      |            |      |            |   |      |            |      |            |      |            |      |            |      |            |      |            |      |            |      |            |      |            |      |            |      |            |      |            |      |            |  |     |                  |     |            |
| 4,2   | 64203 1042  |   |   |                  |   |                  |                |                  |                |   |             |                  |             |                  |             |                  |   |                  |                |                  |                |                  |                |                  |                |                  |                |                  |                |                  |      |                  |      |                  |      |                  |   |     |            |     |            |     |            |     |            |     |            |     |            |     |            |     |            |     |            |     |            |     |            |     |            |     |            |     |            |      |            |      |            |      |            |      |            |   |      |            |      |            |      |            |      |            |      |            |      |            |      |            |      |            |      |            |      |            |      |            |      |            |      |            |  |     |                  |     |            |
| 4,7   | 64203 1047  |   |   |                  |   |                  |                |                  |                |   |             |                  |             |                  |             |                  |   |                  |                |                  |                |                  |                |                  |                |                  |                |                  |                |                  |      |                  |      |                  |      |                  |   |     |            |     |            |     |            |     |            |     |            |     |            |     |            |     |            |     |            |     |            |     |            |     |            |     |            |     |            |      |            |      |            |      |            |      |            |   |      |            |      |            |      |            |      |            |      |            |      |            |      |            |      |            |      |            |      |            |      |            |      |            |      |            |  |     |                  |     |            |
| 5,2   | 64203 1052  |   |   |                  |   |                  |                |                  |                |   |             |                  |             |                  |             |                  |   |                  |                |                  |                |                  |                |                  |                |                  |                |                  |                |                  |      |                  |      |                  |      |                  |   |     |            |     |            |     |            |     |            |     |            |     |            |     |            |     |            |     |            |     |            |     |            |     |            |     |            |     |            |      |            |      |            |      |            |      |            |   |      |            |      |            |      |            |      |            |      |            |      |            |      |            |      |            |      |            |      |            |      |            |      |            |      |            |  |     |                  |     |            |
| 5,7   | 64203 1057  |   |   |                  |   |                  |                |                  |                |   |             |                  |             |                  |             |                  |   |                  |                |                  |                |                  |                |                  |                |                  |                |                  |                |                  |      |                  |      |                  |      |                  |   |     |            |     |            |     |            |     |            |     |            |     |            |     |            |     |            |     |            |     |            |     |            |     |            |     |            |     |            |      |            |      |            |      |            |      |            |   |      |            |      |            |      |            |      |            |      |            |      |            |      |            |      |            |      |            |      |            |      |            |      |            |      |            |  |     |                  |     |            |
| 6,2   | 64203 1062  |   |   |                  |   |                  |                |                  |                |   |             |                  |             |                  |             |                  |   |                  |                |                  |                |                  |                |                  |                |                  |                |                  |                |                  |      |                  |      |                  |      |                  |   |     |            |     |            |     |            |     |            |     |            |     |            |     |            |     |            |     |            |     |            |     |            |     |            |     |            |     |            |      |            |      |            |      |            |      |            |   |      |            |      |            |      |            |      |            |      |            |      |            |      |            |      |            |      |            |      |            |      |            |      |            |      |            |  |     |                  |     |            |
| 6,7   | 64203 1067  |   |   |                  |   |                  |                |                  |                |   |             |                  |             |                  |             |                  |   |                  |                |                  |                |                  |                |                  |                |                  |                |                  |                |                  |      |                  |      |                  |      |                  |   |     |            |     |            |     |            |     |            |     |            |     |            |     |            |     |            |     |            |     |            |     |            |     |            |     |            |     |            |      |            |      |            |      |            |      |            |   |      |            |      |            |      |            |      |            |      |            |      |            |      |            |      |            |      |            |      |            |      |            |      |            |      |            |  |     |                  |     |            |
| 7,2   | 64203 1072  |   |   |                  |   |                  |                |                  |                |   |             |                  |             |                  |             |                  |   |                  |                |                  |                |                  |                |                  |                |                  |                |                  |                |                  |      |                  |      |                  |      |                  |   |     |            |     |            |     |            |     |            |     |            |     |            |     |            |     |            |     |            |     |            |     |            |     |            |     |            |     |            |      |            |      |            |      |            |      |            |   |      |            |      |            |      |            |      |            |      |            |      |            |      |            |      |            |      |            |      |            |      |            |      |            |      |            |  |     |                  |     |            |
| 7,7   | 64203 1077  |   |   |                  |   |                  |                |                  |                |   |             |                  |             |                  |             |                  |   |                  |                |                  |                |                  |                |                  |                |                  |                |                  |                |                  |      |                  |      |                  |      |                  |   |     |            |     |            |     |            |     |            |     |            |     |            |     |            |     |            |     |            |     |            |     |            |     |            |     |            |     |            |      |            |      |            |      |            |      |            |   |      |            |      |            |      |            |      |            |      |            |      |            |      |            |      |            |      |            |      |            |      |            |      |            |      |            |  |     |                  |     |            |
| 8,2   | 64203 1082  |   |   |                  |   |                  |                |                  |                |   |             |                  |             |                  |             |                  |   |                  |                |                  |                |                  |                |                  |                |                  |                |                  |                |                  |      |                  |      |                  |      |                  |   |     |            |     |            |     |            |     |            |     |            |     |            |     |            |     |            |     |            |     |            |     |            |     |            |     |            |     |            |      |            |      |            |      |            |      |            |   |      |            |      |            |      |            |      |            |      |            |      |            |      |            |      |            |      |            |      |            |      |            |      |            |      |            |  |     |                  |     |            |
| 8,7   | 64203 1087  |   |   |                  |   |                  |                |                  |                |   |             |                  |             |                  |             |                  |   |                  |                |                  |                |                  |                |                  |                |                  |                |                  |                |                  |      |                  |      |                  |      |                  |   |     |            |     |            |     |            |     |            |     |            |     |            |     |            |     |            |     |            |     |            |     |            |     |            |     |            |     |            |      |            |      |            |      |            |      |            |   |      |            |      |            |      |            |      |            |      |            |      |            |      |            |      |            |      |            |      |            |      |            |      |            |      |            |  |     |                  |     |            |
| 9,2   | 64203 1092  |   |   |                  |   |                  |                |                  |                |   |             |                  |             |                  |             |                  |   |                  |                |                  |                |                  |                |                  |                |                  |                |                  |                |                  |      |                  |      |                  |      |                  |   |     |            |     |            |     |            |     |            |     |            |     |            |     |            |     |            |     |            |     |            |     |            |     |            |     |            |     |            |      |            |      |            |      |            |      |            |   |      |            |      |            |      |            |      |            |      |            |      |            |      |            |      |            |      |            |      |            |      |            |      |            |      |            |  |     |                  |     |            |
| 9,7   | 64203 1097  |   |   |                  |   |                  |                |                  |                |   |             |                  |             |                  |             |                  |   |                  |                |                  |                |                  |                |                  |                |                  |                |                  |                |                  |      |                  |      |                  |      |                  |   |     |            |     |            |     |            |     |            |     |            |     |            |     |            |     |            |     |            |     |            |     |            |     |            |     |            |     |            |      |            |      |            |      |            |      |            |   |      |            |      |            |      |            |      |            |      |            |      |            |      |            |      |            |      |            |      |            |      |            |      |            |      |            |  |     |                  |     |            |
| 10,2  | 64203 1102  |   |   |                  |   |                  |                |                  |                |   |             |                  |             |                  |             |                  |   |                  |                |                  |                |                  |                |                  |                |                  |                |                  |                |                  |      |                  |      |                  |      |                  |   |     |            |     |            |     |            |     |            |     |            |     |            |     |            |     |            |     |            |     |            |     |            |     |            |     |            |     |            |      |            |      |            |      |            |      |            |   |      |            |      |            |      |            |      |            |      |            |      |            |      |            |      |            |      |            |      |            |      |            |      |            |      |            |  |     |                  |     |            |
| 10,7  | 64203 1107  |   |   |                  |   |                  |                |                  |                |   |             |                  |             |                  |             |                  |   |                  |                |                  |                |                  |                |                  |                |                  |                |                  |                |                  |      |                  |      |                  |      |                  |   |     |            |     |            |     |            |     |            |     |            |     |            |     |            |     |            |     |            |     |            |     |            |     |            |     |            |     |            |      |            |      |            |      |            |      |            |   |      |            |      |            |      |            |      |            |      |            |      |            |      |            |      |            |      |            |      |            |      |            |      |            |      |            |  |     |                  |     |            |
| 11,2  | 64203 1112  |   |   |                  |   |                  |                |                  |                |   |             |                  |             |                  |             |                  |   |                  |                |                  |                |                  |                |                  |                |                  |                |                  |                |                  |      |                  |      |                  |      |                  |   |     |            |     |            |     |            |     |            |     |            |     |            |     |            |     |            |     |            |     |            |     |            |     |            |     |            |     |            |      |            |      |            |      |            |      |            |   |      |            |      |            |      |            |      |            |      |            |      |            |      |            |      |            |      |            |      |            |      |            |      |            |      |            |  |     |                  |     |            |
| 11,7  | 64203 1117  |   |   |                  |   |                  |                |                  |                |   |             |                  |             |                  |             |                  |   |                  |                |                  |                |                  |                |                  |                |                  |                |                  |                |                  |      |                  |      |                  |      |                  |   |     |            |     |            |     |            |     |            |     |            |     |            |     |            |     |            |     |            |     |            |     |            |     |            |     |            |     |            |      |            |      |            |      |            |      |            |   |      |            |      |            |      |            |      |            |      |            |      |            |      |            |      |            |      |            |      |            |      |            |      |            |      |            |  |     |                  |     |            |
| 12,2  | 64203 1122  |   |   |                  |   |                  |                |                  |                |   |             |                  |             |                  |             |                  |   |                  |                |                  |                |                  |                |                  |                |                  |                |                  |                |                  |      |                  |      |                  |      |                  |   |     |            |     |            |     |            |     |            |     |            |     |            |     |            |     |            |     |            |     |            |     |            |     |            |     |            |     |            |      |            |      |            |      |            |      |            |   |      |            |      |            |      |            |      |            |      |            |      |            |      |            |      |            |      |            |      |            |      |            |      |            |      |            |  |     |                  |     |            |
| 12,7  | 64203 1127  |   |   |                  |   |                  |                |                  |                |   |             |                  |             |                  |             |                  |   |                  |                |                  |                |                  |                |                  |                |                  |                |                  |                |                  |      |                  |      |                  |      |                  |   |     |            |     |            |     |            |     |            |     |            |     |            |     |            |     |            |     |            |     |            |     |            |     |            |     |            |     |            |      |            |      |            |      |            |      |            |   |      |            |      |            |      |            |      |            |      |            |      |            |      |            |      |            |      |            |      |            |      |            |      |            |      |            |  |     |                  |     |            |
| 13,2  | 64203 1132  |   |   |                  |   |                  |                |                  |                |   |             |                  |             |                  |             |                  |   |                  |                |                  |                |                  |                |                  |                |                  |                |                  |                |                  |      |                  |      |                  |      |                  |   |     |            |     |            |     |            |     |            |     |            |     |            |     |            |     |            |     |            |     |            |     |            |     |            |     |            |     |            |      |            |      |            |      |            |      |            |   |      |            |      |            |      |            |      |            |      |            |      |            |      |            |      |            |      |            |      |            |      |            |      |            |      |            |  |     |                  |     |            |
| 13,7  | 64203 1137  |   |   |                  |   |                  |                |                  |                |   |             |                  |             |                  |             |                  |   |                  |                |                  |                |                  |                |                  |                |                  |                |                  |                |                  |      |                  |      |                  |      |                  |   |     |            |     |            |     |            |     |            |     |            |     |            |     |            |     |            |     |            |     |            |     |            |     |            |     |            |     |            |      |            |      |            |      |            |      |            |   |      |            |      |            |      |            |      |            |      |            |      |            |      |            |      |            |      |            |      |            |      |            |      |            |      |            |  |     |                  |     |            |
| 14,2  | 64203 1142  |   |   |                  |   |                  |                |                  |                |   |             |                  |             |                  |             |                  |   |                  |                |                  |                |                  |                |                  |                |                  |                |                  |                |                  |      |                  |      |                  |      |                  |   |     |            |     |            |     |            |     |            |     |            |     |            |     |            |     |            |     |            |     |            |     |            |     |            |     |            |     |            |      |            |      |            |      |            |      |            |   |      |            |      |            |      |            |      |            |      |            |      |            |      |            |      |            |      |            |      |            |      |            |      |            |      |            |  |     |                  |     |            |
| 14,7  | 64203 1147  |   |   |                  |   |                  |                |                  |                |   |             |                  |             |                  |             |                  |   |                  |                |                  |                |                  |                |                  |                |                  |                |                  |                |                  |      |                  |      |                  |      |                  |   |     |            |     |            |     |            |     |            |     |            |     |            |     |            |     |            |     |            |     |            |     |            |     |            |     |            |     |            |      |            |      |            |      |            |      |            |   |      |            |      |            |      |            |      |            |      |            |      |            |      |            |      |            |      |            |      |            |      |            |      |            |      |            |  |     |                  |     |            |
| 15,2  | 64203 1152  |   |   |                  |   |                  |                |                  |                |   |             |                  |             |                  |             |                  |   |                  |                |                  |                |                  |                |                  |                |                  |                |                  |                |                  |      |                  |      |                  |      |                  |   |     |            |     |            |     |            |     |            |     |            |     |            |     |            |     |            |     |            |     |            |     |            |     |            |     |            |     |            |      |            |      |            |      |            |      |            |   |      |            |      |            |      |            |      |            |      |            |      |            |      |            |      |            |      |            |      |            |      |            |      |            |      |            |  |     |                  |     |            |
| 15,7  | 64203 1157  |   |   |                  |   |                  |                |                  |                |   |             |                  |             |                  |             |                  |   |                  |                |                  |                |                  |                |                  |                |                  |                |                  |                |                  |      |                  |      |                  |      |                  |   |     |            |     |            |     |            |     |            |     |            |     |            |     |            |     |            |     |            |     |            |     |            |     |            |     |            |     |            |      |            |      |            |      |            |      |            |   |      |            |      |            |      |            |      |            |      |            |      |            |      |            |      |            |      |            |      |            |      |            |      |            |      |            |  |     |                  |     |            |
| 16,2  | 64203 1162  |   |   |                  |   |                  |                |                  |                |   |             |                  |             |                  |             |                  |   |                  |                |                  |                |                  |                |                  |                |                  |                |                  |                |                  |      |                  |      |                  |      |                  |   |     |            |     |            |     |            |     |            |     |            |     |            |     |            |     |            |     |            |     |            |     |            |     |            |     |            |     |            |      |            |      |            |      |            |      |            |   |      |            |      |            |      |            |      |            |      |            |      |            |      |            |      |            |      |            |      |            |      |            |      |            |      |            |  |     |                  |     |            |
| 16,7  | 64203 1167  |   |   |                  |   |                  |                |                  |                |   |             |                  |             |                  |             |                  |   |                  |                |                  |                |                  |                |                  |                |                  |                |                  |                |                  |      |                  |      |                  |      |                  |   |     |            |     |            |     |            |     |            |     |            |     |            |     |            |     |            |     |            |     |            |     |            |     |            |     |            |     |            |      |            |      |            |      |            |      |            |   |      |            |      |            |      |            |      |            |      |            |      |            |      |            |      |            |      |            |      |            |      |            |      |            |      |            |  |     |                  |     |            |
| 17,2  | 64203 1172  |   |   |                  |   |                  |                |                  |                |   |             |                  |             |                  |             |                  |   |                  |                |                  |                |                  |                |                  |                |                  |                |                  |                |                  |      |                  |      |                  |      |                  |   |     |            |     |            |     |            |     |            |     |            |     |            |     |            |     |            |     |            |     |            |     |            |     |            |     |            |     |            |      |            |      |            |      |            |      |            |   |      |            |      |            |      |            |      |            |      |            |      |            |      |            |      |            |      |            |      |            |      |            |      |            |      |            |  |     |                  |     |            |
| 17,7  | 64203 1177  |   |   |                  |   |                  |                |                  |                |   |             |                  |             |                  |             |                  |   |                  |                |                  |                |                  |                |                  |                |                  |                |                  |                |                  |      |                  |      |                  |      |                  |   |     |            |     |            |     |            |     |            |     |            |     |            |     |            |     |            |     |            |     |            |     |            |     |            |     |            |     |            |      |            |      |            |      |            |      |            |   |      |            |      |            |      |            |      |            |      |            |      |            |      |            |      |            |      |            |      |            |      |            |      |            |      |            |  |     |                  |     |            |
| 18,2  | 64203 1182  |   |   |                  |   |                  |                |                  |                |   |             |                  |             |                  |             |                  |   |                  |                |                  |                |                  |                |                  |                |                  |                |                  |                |                  |      |                  |      |                  |      |                  |   |     |            |     |            |     |            |     |            |     |            |     |            |     |            |     |            |     |            |     |            |     |            |     |            |     |            |     |            |      |            |      |            |      |            |      |            |   |      |            |      |            |      |            |      |            |      |            |      |            |      |            |      |            |      |            |      |            |      |            |      |            |      |            |  |     |                  |     |            |
| 9,0   | P-65002 8014 090  |   |   |                  |   |                  |                |                  |                |   |             |                  |             |                  |             |                  |   |                  |                |                  |                |                  |                |                  |                |                  |                |                  |                |                  |      |                  |      |                  |      |                  |   |     |            |     |            |     |            |     |            |     |            |     |            |     |            |     |            |     |            |     |            |     |            |     |            |     |            |     |            |      |            |      |            |      |            |      |            |   |      |            |      |            |      |            |      |            |      |            |      |            |      |            |      |            |      |            |      |            |      |            |      |            |      |            |  |     |                  |     |            |
| 9,7   | 64203 2097  |   |   |                  |   |                  |                |                  |                |   |             |                  |             |                  |             |                  |   |                  |                |                  |                |                  |                |                  |                |                  |                |                  |                |                  |      |                  |      |                  |      |                  |   |     |            |     |            |     |            |     |            |     |            |     |            |     |            |     |            |     |            |     |            |     |            |     |            |     |            |     |            |      |            |      |            |      |            |      |            |   |      |            |      |            |      |            |      |            |      |            |      |            |      |            |      |            |      |            |      |            |      |            |      |            |      |            |  |     |                  |     |            |
| <b>punzón ovalado especial</b>  | <b>matriz ovalada (estándar)</b>  | <b>punzón ovalado especial</b>  | <b>matriz ovalada (estándar)</b>  |                  |   |                  |                |                  |                |   |             |                  |             |                  |             |                  |   |                  |                |                  |                |                  |                |                  |                |                  |                |                  |                |                  |      |                  |      |                  |      |                  |   |     |            |     |            |     |            |     |            |     |            |     |            |     |            |     |            |     |            |     |            |     |            |     |            |     |            |     |            |      |            |      |            |      |            |      |            |   |      |            |      |            |      |            |      |            |      |            |      |            |      |            |      |            |      |            |      |            |      |            |      |            |      |            |  |     |                  |     |            |
| <b>No 2</b>   | <b>No 3</b>   | <b>No 5</b>   | <b>No 3</b>   |                  |   |                  |                |                  |                |   |             |                  |             |                  |             |                  |   |                  |                |                  |                |                  |                |                  |                |                  |                |                  |                |                  |      |                  |      |                  |      |                  |   |     |            |     |            |     |            |     |            |     |            |     |            |     |            |     |            |     |            |     |            |     |            |     |            |     |            |     |            |      |            |      |            |      |            |      |            |   |      |            |      |            |      |            |      |            |      |            |      |            |      |            |      |            |      |            |      |            |      |            |      |            |      |            |  |     |                  |     |            |
|    |                |               |                |                  |   |                  |                |                  |                |   |             |                  |             |                  |             |                  |   |                  |                |                  |                |                  |                |                  |                |                  |                |                  |                |                  |      |                  |      |                  |      |                  |   |     |            |     |            |     |            |     |            |     |            |     |            |     |            |     |            |     |            |     |            |     |            |     |            |     |            |     |            |      |            |      |            |      |            |      |            |   |      |            |      |            |      |            |      |            |      |            |      |            |      |            |      |            |      |            |      |            |      |            |      |            |      |            |  |     |                  |     |            |
|  N° referencia   |  N° referencia |  N° referencia |  N° referencia |                  |   |                  |                |                  |                |   |             |                  |             |                  |             |                  |   |                  |                |                  |                |                  |                |                  |                |                  |                |                  |                |                  |      |                  |      |                  |      |                  |   |     |            |     |            |     |            |     |            |     |            |     |            |     |            |     |            |     |            |     |            |     |            |     |            |     |            |     |            |      |            |      |            |      |            |      |            |   |      |            |      |            |      |            |      |            |      |            |      |            |      |            |      |            |      |            |      |            |      |            |      |            |      |            |  |     |                  |     |            |
| <table border="0"> <tr><td>9,0 × 14,0</td><td>P-65002 8013 01</td></tr> <tr><td>9,0 × 18,0</td><td>P-65002 8013 03</td></tr> </table>   | 9,0 × 14,0  | P-65002 8013 01   | 9,0 × 18,0  | P-65002 8013 03  | <table border="0"> <tr><td>9,7 × 14,7</td><td>64203 3 097147</td></tr> <tr><td>9,7 × 18,7</td><td>64203 3 097187</td></tr> </table> | 9,7 × 14,7       | 64203 3 097147 | 9,7 × 18,7       | 64203 3 097187 | <table border="0"> <tr><td>10,0 × 30,0</td><td>P-65005 8024 01</td></tr> <tr><td>11,0 × 26,0</td><td>P-65005 8024 04</td></tr> <tr><td>11,0 × 30,0</td><td>P-65005 8024 03</td></tr> </table> | 10,0 × 30,0 | P-65005 8024 01  | 11,0 × 26,0 | P-65005 8024 04  | 11,0 × 30,0 | P-65005 8024 03  | <table border="0"> <tr><td>10,7 × 30,7</td><td>64203 3 107307</td></tr> <tr><td>11,2 × 31,2</td><td>64203 3 112312</td></tr> <tr><td>11,7 × 26,7</td><td>64203 3 117267</td></tr> <tr><td>12,2 × 27,2</td><td>64203 3 122272</td></tr> <tr><td>11,7 × 30,7</td><td>64203 3 117307</td></tr> <tr><td>12,2 × 31,2</td><td>64203 3 122312</td></tr> </table> | 10,7 × 30,7      | 64203 3 107307 | 11,2 × 31,2      | 64203 3 112312 | 11,7 × 26,7      | 64203 3 117267 | 12,2 × 27,2      | 64203 3 122272 | 11,7 × 30,7      | 64203 3 117307 | 12,2 × 31,2      | 64203 3 122312 |                  |      |                  |      |                  |      |                  |   |     |            |     |            |     |            |     |            |     |            |     |            |     |            |     |            |     |            |     |            |     |            |     |            |     |            |     |            |      |            |      |            |      |            |      |            |   |      |            |      |            |      |            |      |            |      |            |      |            |      |            |      |            |      |            |      |            |      |            |      |            |      |            |  |     |                  |     |            |
| 9,0 × 14,0  | P-65002 8013 01   |   |   |                  |   |                  |                |                  |                |   |             |                  |             |                  |             |                  |   |                  |                |                  |                |                  |                |                  |                |                  |                |                  |                |                  |      |                  |      |                  |      |                  |   |     |            |     |            |     |            |     |            |     |            |     |            |     |            |     |            |     |            |     |            |     |            |     |            |     |            |     |            |      |            |      |            |      |            |      |            |   |      |            |      |            |      |            |      |            |      |            |      |            |      |            |      |            |      |            |      |            |      |            |      |            |      |            |  |     |                  |     |            |
| 9,0 × 18,0  | P-65002 8013 03   |   |   |                  |   |                  |                |                  |                |   |             |                  |             |                  |             |                  |   |                  |                |                  |                |                  |                |                  |                |                  |                |                  |                |                  |      |                  |      |                  |      |                  |   |     |            |     |            |     |            |     |            |     |            |     |            |     |            |     |            |     |            |     |            |     |            |     |            |     |            |     |            |      |            |      |            |      |            |      |            |   |      |            |      |            |      |            |      |            |      |            |      |            |      |            |      |            |      |            |      |            |      |            |      |            |      |            |  |     |                  |     |            |
| 9,7 × 14,7  | 64203 3 097147  |   |   |                  |   |                  |                |                  |                |   |             |                  |             |                  |             |                  |   |                  |                |                  |                |                  |                |                  |                |                  |                |                  |                |                  |      |                  |      |                  |      |                  |   |     |            |     |            |     |            |     |            |     |            |     |            |     |            |     |            |     |            |     |            |     |            |     |            |     |            |     |            |      |            |      |            |      |            |      |            |   |      |            |      |            |      |            |      |            |      |            |      |            |      |            |      |            |      |            |      |            |      |            |      |            |      |            |  |     |                  |     |            |
| 9,7 × 18,7  | 64203 3 097187  |   |   |                  |   |                  |                |                  |                |   |             |                  |             |                  |             |                  |   |                  |                |                  |                |                  |                |                  |                |                  |                |                  |                |                  |      |                  |      |                  |      |                  |   |     |            |     |            |     |            |     |            |     |            |     |            |     |            |     |            |     |            |     |            |     |            |     |            |     |            |     |            |      |            |      |            |      |            |      |            |   |      |            |      |            |      |            |      |            |      |            |      |            |      |            |      |            |      |            |      |            |      |            |      |            |      |            |  |     |                  |     |            |
| 10,0 × 30,0   | P-65005 8024 01   |   |   |                  |   |                  |                |                  |                |   |             |                  |             |                  |             |                  |   |                  |                |                  |                |                  |                |                  |                |                  |                |                  |                |                  |      |                  |      |                  |      |                  |   |     |            |     |            |     |            |     |            |     |            |     |            |     |            |     |            |     |            |     |            |     |            |     |            |     |            |     |            |      |            |      |            |      |            |      |            |   |      |            |      |            |      |            |      |            |      |            |      |            |      |            |      |            |      |            |      |            |      |            |      |            |      |            |  |     |                  |     |            |
| 11,0 × 26,0   | P-65005 8024 04   |   |   |                  |   |                  |                |                  |                |   |             |                  |             |                  |             |                  |   |                  |                |                  |                |                  |                |                  |                |                  |                |                  |                |                  |      |                  |      |                  |      |                  |   |     |            |     |            |     |            |     |            |     |            |     |            |     |            |     |            |     |            |     |            |     |            |     |            |     |            |     |            |      |            |      |            |      |            |      |            |   |      |            |      |            |      |            |      |            |      |            |      |            |      |            |      |            |      |            |      |            |      |            |      |            |      |            |  |     |                  |     |            |
| 11,0 × 30,0   | P-65005 8024 03   |   |   |                  |   |                  |                |                  |                |   |             |                  |             |                  |             |                  |   |                  |                |                  |                |                  |                |                  |                |                  |                |                  |                |                  |      |                  |      |                  |      |                  |   |     |            |     |            |     |            |     |            |     |            |     |            |     |            |     |            |     |            |     |            |     |            |     |            |     |            |     |            |      |            |      |            |      |            |      |            |   |      |            |      |            |      |            |      |            |      |            |      |            |      |            |      |            |      |            |      |            |      |            |      |            |      |            |  |     |                  |     |            |
| 10,7 × 30,7   | 64203 3 107307  |   |   |                  |   |                  |                |                  |                |   |             |                  |             |                  |             |                  |   |                  |                |                  |                |                  |                |                  |                |                  |                |                  |                |                  |      |                  |      |                  |      |                  |   |     |            |     |            |     |            |     |            |     |            |     |            |     |            |     |            |     |            |     |            |     |            |     |            |     |            |     |            |      |            |      |            |      |            |      |            |   |      |            |      |            |      |            |      |            |      |            |      |            |      |            |      |            |      |            |      |            |      |            |      |            |      |            |  |     |                  |     |            |
| 11,2 × 31,2   | 64203 3 112312  |   |   |                  |   |                  |                |                  |                |   |             |                  |             |                  |             |                  |   |                  |                |                  |                |                  |                |                  |                |                  |                |                  |                |                  |      |                  |      |                  |      |                  |   |     |            |     |            |     |            |     |            |     |            |     |            |     |            |     |            |     |            |     |            |     |            |     |            |     |            |     |            |      |            |      |            |      |            |      |            |   |      |            |      |            |      |            |      |            |      |            |      |            |      |            |      |            |      |            |      |            |      |            |      |            |      |            |  |     |                  |     |            |
| 11,7 × 26,7   | 64203 3 117267  |   |   |                  |   |                  |                |                  |                |   |             |                  |             |                  |             |                  |   |                  |                |                  |                |                  |                |                  |                |                  |                |                  |                |                  |      |                  |      |                  |      |                  |   |     |            |     |            |     |            |     |            |     |            |     |            |     |            |     |            |     |            |     |            |     |            |     |            |     |            |     |            |      |            |      |            |      |            |      |            |   |      |            |      |            |      |            |      |            |      |            |      |            |      |            |      |            |      |            |      |            |      |            |      |            |      |            |  |     |                  |     |            |
| 12,2 × 27,2   | 64203 3 122272  |   |   |                  |   |                  |                |                  |                |   |             |                  |             |                  |             |                  |   |                  |                |                  |                |                  |                |                  |                |                  |                |                  |                |                  |      |                  |      |                  |      |                  |   |     |            |     |            |     |            |     |            |     |            |     |            |     |            |     |            |     |            |     |            |     |            |     |            |     |            |     |            |      |            |      |            |      |            |      |            |   |      |            |      |            |      |            |      |            |      |            |      |            |      |            |      |            |      |            |      |            |      |            |      |            |      |            |  |     |                  |     |            |
| 11,7 × 30,7   | 64203 3 117307  |   |   |                  |   |                  |                |                  |                |   |             |                  |             |                  |             |                  |   |                  |                |                  |                |                  |                |                  |                |                  |                |                  |                |                  |      |                  |      |                  |      |                  |   |     |            |     |            |     |            |     |            |     |            |     |            |     |            |     |            |     |            |     |            |     |            |     |            |     |            |     |            |      |            |      |            |      |            |      |            |   |      |            |      |            |      |            |      |            |      |            |      |            |      |            |      |            |      |            |      |            |      |            |      |            |      |            |  |     |                  |     |            |
| 12,2 × 31,2   | 64203 3 122312  |   |   |                  |   |                  |                |                  |                |   |             |                  |             |                  |             |                  |   |                  |                |                  |                |                  |                |                  |                |                  |                |                  |                |                  |      |                  |      |                  |      |                  |   |     |            |     |            |     |            |     |            |     |            |     |            |     |            |     |            |     |            |     |            |     |            |     |            |     |            |     |            |      |            |      |            |      |            |      |            |   |      |            |      |            |      |            |      |            |      |            |      |            |      |            |      |            |      |            |      |            |      |            |      |            |      |            |  |     |                  |     |            |