

MUBEA-Norm • MUBEA Style • Type MUBEA

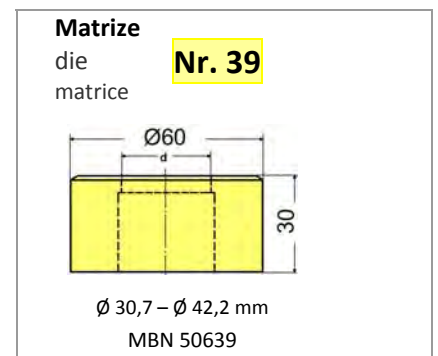

Reduzierungen • reducers • réducteurs

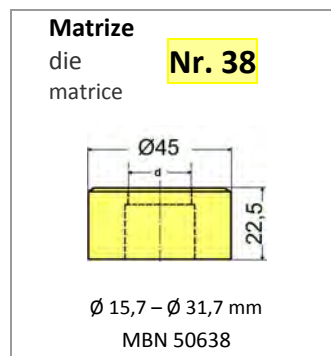
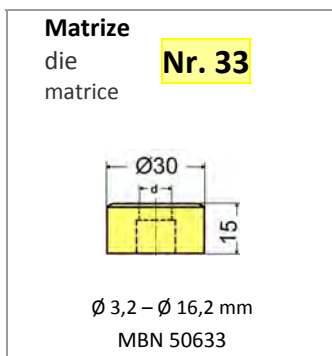
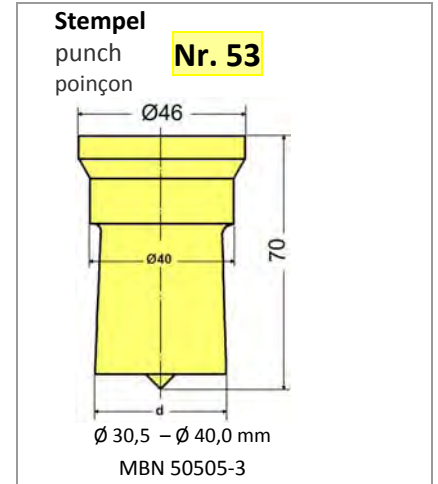
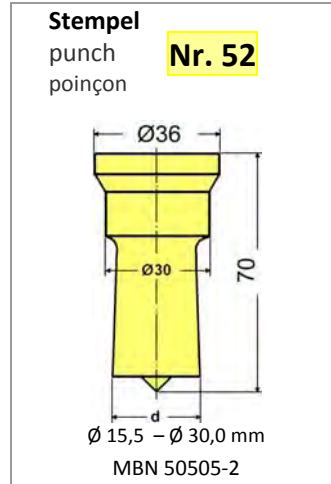
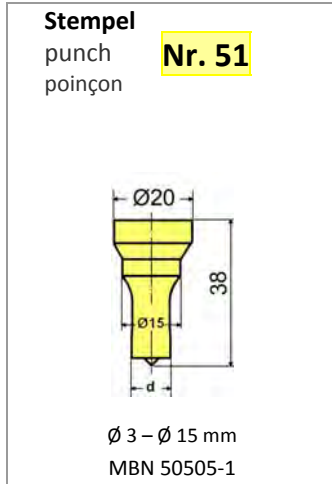
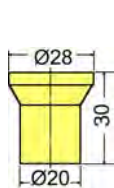

Stempelbeilage
punch sleeve
garniture de poinçon
10505 290 00 00

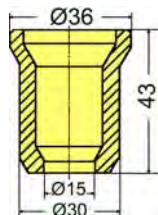

Einsatzbuchse 30/15
punch reducing sleeve
réducteur poinçon
10505 313 00 00

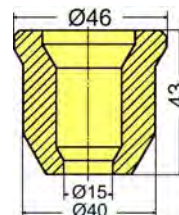

Einsatzbuchse IV/I
punch reducing sleeve
réducteur poinçon
10505 314 00 00

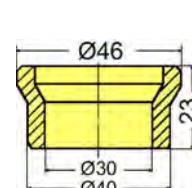

Einsatzbuchse 40/30
punch reducing sleeve
réducteur poinçon
10505 315 00 00

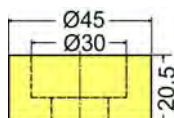

Matrizenreduzierung 45/30
die reducing socket
réducteur matrice
10506 061 00 00

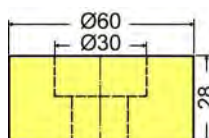

Matrizenreduzierung 60/30
die reducing socket
réducteur matrice
10506 062 00 00

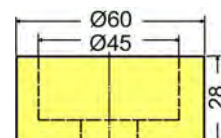





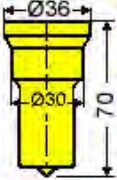
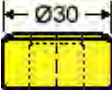
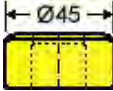
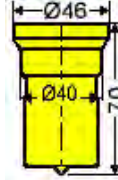
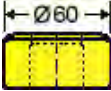

Matrizenreduzierung 60/45
die reducing socket
réducteur matrice
10506 063 00 00

MUBEA-Norm • MUBEA Style • Type MUBEA

Rundstempel round punch poinçon rond	Rundmatrize round die matrice ronde	Rundstempel round punch poinçon rond	Rundmatrize round die matrice ronde	Rundstempel round punch poinçon rond	Rundmatrize round die matrice ronde
Nr. 51	Nr. 33	Nr. 52	Nr. 38	Nr. 53	Nr. 39
MBN 50505-1	MBN 50633	MBN 50505-2	MBN 50638	MBN 50505-3	MBN 50639
Artikel-Nr.	Artikel-Nr.	Artikel-Nr.	Artikel-Nr.	Artikel-Nr.	Artikel-Nr.
3,0 15051 1030	3,2 10633 1032	15,5 15052 1155	15,7 10638 1157	30,5 15053 1305	30,7 10639 1307
3,5 15051 1035	3,7 10633 1037	16,0 15052 1160	16,2 10638 1162	31,0 15053 1310	31,2 10639 1312
4,0 15051 1040	4,2 10633 1042	16,5 15052 1165	16,7 10638 1167	31,5 15053 1315	31,7 10639 1317
4,5 15051 1045	4,7 10633 1047	17,0 15052 1170	17,2 10638 1172	32,0 15053 1320	32,2 10639 1322
5,0 15051 1050	5,2 10633 1052	17,5 15052 1175	17,7 10638 1177	32,5 15053 1325	32,7 10639 1327
5,5 15051 1055	5,7 10633 1057	18,0 15052 1180	18,2 10638 1182	33,0 15053 1330	33,2 10639 1332
6,0 15051 1060	6,2 10633 1062	18,5 15052 1185	18,7 10638 1187	33,5 15053 1335	33,7 10639 1337
6,5 15051 1065	6,7 10633 1067	19,0 15052 1190	19,2 10638 1192	34,0 15053 1340	34,2 10639 1342
7,0 15051 1070	7,2 10633 1072	19,5 15052 1195	19,7 10638 1197	34,5 15053 1345	34,7 10639 1347
7,5 15051 1075	7,7 10633 1077	20,0 15052 1200	20,2 10638 1202	35,0 15053 1350	35,2 10639 1352
8,0 15051 1080	8,2 10633 1082	20,5 15052 1205	20,7 10638 1207	35,5 15053 1355	35,7 10639 1357
8,5 15051 1085	8,7 10633 1087	21,0 15052 1210	21,2 10638 1212	36,0 15053 1360	36,2 10639 1362
9,0 15051 1090	9,2 10633 1092	21,5 15052 1215	21,7 10638 1217	36,5 15053 1365	36,7 10639 1367
9,5 15051 1095	9,7 10633 1097	22,0 15052 1220	22,2 10638 1222	37,0 15053 1370	37,2 10639 1372
10,0 15051 1100	10,2 10633 1102	22,5 15052 1225	22,7 10638 1227	37,5 15053 1375	37,7 10639 1377
10,5 15051 1105	10,7 10633 1107	23,0 15052 1230	23,2 10638 1232	38,0 15053 1380	38,2 10639 1382
11,0 15051 1110	11,2 10633 1112	23,5 15052 1235	23,7 10638 1237	38,5 15053 1385	38,7 10639 1387
11,5 15051 1115	11,7 10633 1117	24,0 15052 1240	24,2 10638 1242	39,0 15053 1390	39,2 10639 1392
12,0 15051 1120	12,2 10633 1122	24,5 15052 1245	24,7 10638 1247	39,5 15053 1395	39,7 10639 1397
12,5 15051 1125	12,7 10633 1127	25,0 15052 1250	25,2 10638 1252	40,0 15053 1400	40,2 10639 1402
13,0 15051 1130	13,2 10633 1132	25,5 15052 1255	25,7 10638 1257		40,7 10639 1407
13,5 15051 1135	13,7 10633 1137	26,0 15052 1260	26,2 10638 1262		41,2 10639 1412
14,0 15051 1140	14,2 10633 1142	26,5 15052 1265	26,7 10638 1267		41,7 10639 1417
14,5 15051 1145	14,7 10633 1147	27,0 15052 1270	27,2 10638 1272		42,2 10639 1422
15,0 15051 1150	15,2 10633 1152	27,5 15052 1275	27,7 10638 1277		
	15,7 10633 1157	28,0 15052 1280	28,2 10638 1282		
	16,2 10633 1162	28,5 15052 1285	28,7 10638 1287		
		29,0 15052 1290	29,2 10638 1292		
		29,5 15052 1295	29,7 10638 1297		
		30,0 15052 1300	30,2 10638 1302		
			30,7 10638 1307		
			31,2 10638 1312		
			31,7 10638 1317		

MUBEA-Norm • MUBEA Style • Type MUBEA

Vierkantstempel square punch poinçon carré	Vierkantmatrize square die matrice carrée	Vierkantmatrize square die matrice carrée	Vierkantstempel square punch poinçon carré	Vierkantmatrize square die matrice carrée
Nr. 52	Nr. 33	Nr. 38	Nr. 53	Nr. 39
				
MBN 50505-2	MBN 50633	MBN 50638	MBN 50505-3	MBN 50639
 Artikel-Nr.	 Artikel-Nr.	 Artikel-Nr.	 Artikel-Nr.	 Artikel-Nr.
4,0 15052 2040	4,2 10633 2042	11,7 10638 2117	21,5 15053 2215	21,7 10639 2217
4,5 15052 2045	4,7 10633 2047	12,2 10638 2122	22,0 15053 2220	22,2 10639 2222
5,0 15052 2050	5,2 10633 2052	12,7 10638 2127	22,5 15053 2225	22,7 10639 2227
5,5 15052 2055	5,7 10633 2057	13,2 10638 2132	23,0 15053 2230	23,2 10639 2232
6,0 15052 2060	6,2 10633 2062	13,7 10638 2137	23,5 15053 2235	23,7 10639 2237
6,5 15052 2065	6,7 10633 2067	14,2 10638 2142	24,0 15053 2240	24,2 10639 2242
7,0 15052 2070	7,2 10633 2072	14,7 10638 2147	24,5 15053 2245	24,7 10639 2247
7,5 15052 2075	7,7 10633 2077	15,2 10638 2152	25,0 15053 2250	25,2 10639 2252
8,0 15052 2080	8,2 10633 2082	15,7 10638 2157	25,5 15053 2255	25,7 10639 2257
8,5 15052 2085	8,7 10633 2087	16,2 10638 2162	26,0 15053 2260	26,2 10639 2262
9,0 15052 2090	9,2 10633 2092	16,7 10638 2167	26,5 15053 2265	26,7 10639 2267
9,5 15052 2095	9,7 10633 2097	17,2 10638 2172	27,0 15053 2270	27,2 10639 2272
10,0 15052 2100	10,2 10633 2102	17,7 10638 2177	27,5 15053 2275	27,7 10639 2277
10,5 15052 2105	10,7 10633 2107	18,2 10638 2182	28,0 15053 2280	28,2 10639 2282
11,0 15052 2110	11,2 10633 2112	18,7 10638 2187		28,7 10639 2287
11,5 15052 2115		19,2 10638 2192		29,2 10639 2292
12,0 15052 2120		19,7 10638 2197		
12,5 15052 2125		20,2 10638 2202		
13,0 15052 2130		20,7 10638 2207		
13,5 15052 2135		21,2 10638 2212		
14,0 15052 2140		21,7 10638 2217		
14,5 15052 2145		22,2 10638 2222		
15,0 15052 2150				
15,5 15052 2155				
16,0 15052 2160				
16,5 15052 2165				
17,0 15052 2170				
17,5 15052 2175				
18,0 15052 2180				
18,5 15052 2185				
19,0 15052 2190				
19,5 15052 2195				
20,0 15052 2200				
20,5 15052 2205				
21,0 15052 2210				

MUBEA-Norm • MUBEA Style • Type MUBEA

Langlochstempel oblong punch poinçon oblong	Langlochmatrize oblong die matrice oblongue	Langlochstempel oblong punch poinçon oblong	Langlochmatrize oblong die matrice oblongue
Nr. 52	Nr. 33	Nr. 52	Nr. 38
MBN 50505-2	MBN 50633	MBN 50505-2	MBN 50638
Artikel-Nr.	Artikel-Nr.	Artikel-Nr.	Artikel-Nr.
5,0 × 10,0 15052 3050100	5,3 × 10,3 10633 3053103	5,0 × 20,0 15052 3050200	5,3 × 20,3 10638 3053203
5,0 × 13,0 15052 3050130	6,0 × 11,0 10633 3060110	5,0 × 25,0 15052 3050250	6,0 × 21,0 10638 3060210
5,0 × 15,0 15052 3050150	5,3 × 13,3 10633 3053133	5,5 × 20,0 15052 3055200	5,3 × 25,3 10638 3053253
5,5 × 11,0 15052 3055110	6,0 × 14,0 10633 3060140	5,5 × 25,0 15052 3055250	6,0 × 26,0 10638 3060260
5,5 × 13,0 15052 3055130	5,3 × 15,3 10633 3053153	6,5 × 20,0 15052 3065200	5,8 × 20,3 10638 3058203
5,5 × 15,0 15052 3055150	6,0 × 16,0 10633 3060160	6,5 × 25,0 15052 3065250	6,5 × 21,0 10638 3065210
6,5 × 13,0 15052 3065130	5,8 × 11,3 10633 3058113	6,5 × 30,0 15052 3065300	5,8 × 25,3 10638 3058253
6,5 × 15,0 15052 3065150	6,5 × 12,0 10633 3065120	7,0 × 20,0 15052 3070200	6,5 × 26,0 10638 3065260
7,0 × 15,0 15052 3070150	5,8 × 13,3 10633 3058133	7,0 × 25,0 15052 3070250	6,8 × 20,3 10638 3068203
8,0 × 13,0 15052 3080130	6,5 × 14,0 10633 3065140	7,0 × 30,0 15052 3070300	7,5 × 21,0 10638 3075210
9,0 × 13,0 15052 3090130	5,8 × 15,3 10633 3058153	8,0 × 16,0 15052 3080160	6,8 × 25,3 10638 3068253
9,5 × 13,0 15052 3095130	6,5 × 16,0 10633 3065160	8,0 × 20,0 15052 3080200	7,5 × 26,0 10638 3075260
9,5 × 15,0 15052 3095150	6,8 × 13,3 10633 3068133	8,0 × 25,0 15052 3080250	6,8 × 30,3 10638 3068303
10,5 × 15,0 15052 3105150	7,5 × 14,0 10633 3075140	8,0 × 30,0 15052 3080300	7,5 × 31,0 10638 3075310
11,0 × 15,0 15052 3110150	6,8 × 15,3 10633 3068153	9,0 × 18,0 15052 3090180	7,3 × 20,3 10638 3073203
	7,5 × 16,0 10633 3075160	9,0 × 20,0 15052 3090200	8,0 × 21,0 10638 3080210
	7,3 × 15,3 10633 3073153	9,0 × 25,0 15052 3090250	7,3 × 25,3 10638 3073253
	8,0 × 16,0 10633 3080160		8,0 × 26,0 10638 3080260
	8,3 × 13,3 10633 3083133		7,3 × 30,3 10638 3073303
	9,0 × 14,0 10633 3090140		8,0 × 31,0 10638 3080310
	9,3 × 13,3 10633 3093133		8,3 × 16,3 10638 3083163
	10,0 × 14,0 10633 3100140		9,0 × 17,0 10638 3090170
	9,8 × 13,3 10633 3098133		8,3 × 20,3 10638 3083203
	10,5 × 14,0 10633 3105140		9,0 × 21,0 10638 3090210
	9,8 × 15,3 10633 3098153		8,3 × 25,3 10638 3083253
	10,5 × 16,0 10633 3105160		9,0 × 26,0 10638 3090260
	10,8 × 15,3 10633 3108153		8,3 × 30,3 10638 3083303
	11,5 × 16,0 10633 3115160		9,0 × 31,0 10638 3090310
	11,3 × 15,3 10633 3113153		9,3 × 18,3 10638 3093183
	12,0 × 16,0 10633 3120160		10,0 × 19,0 10638 3100190
			9,3 × 20,3 10638 3093203
			10,0 × 21,0 10638 3100210
			9,3 × 25,3 10638 3093253
			10,0 × 26,0 10638 3100260

MUBEA-Norm • MUBEA Style • Type MUBEA

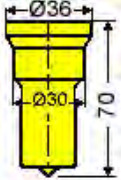
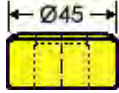
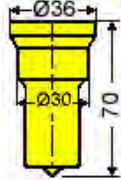
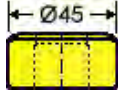
Langlochstempel oblong punch poinçon oblong	Langlochmatrize oblong die matrice oblongue	Langlochstempel oblong punch poinçon oblong	Langlochmatrize oblong die matrice oblongue
Nr. 52	Nr. 38	Nr. 52	Nr. 38
			
MBN 50505-2	MBN 50638	MBN 50505-2	MBN 50638
Artikel-Nr.	Artikel-Nr.	Artikel-Nr.	Artikel-Nr.
9,0 × 30,0 15052 3090300	9,3 × 30,3 10638 3093303	13,5 × 20,0 15052 3135200	13,8 × 20,3 10638 3138203
9,5 × 20,0 15052 3095200	10,0 × 31,0 10638 3100310	13,5 × 25,0 15052 3135250	14,5 × 21,0 10638 3145210
9,5 × 25,0 15052 3095250	9,8 × 20,3 10638 3098203	13,5 × 30,0 15052 3135300	13,8 × 25,3 10638 3138253
9,5 × 30,0 15052 3095300	10,5 × 21,0 10638 3105210	14,0 × 20,0 15052 3140200	14,5 × 26,0 10638 3145260
10,5 × 21,0 15052 3105210	9,8 × 25,3 10638 3098253	14,0 × 25,0 15052 3140250	13,8 × 30,3 10638 3138303
10,5 × 25,0 15052 3105250	10,5 × 26,0 10638 3105260	14,0 × 30,0 15052 3140300	14,5 × 31,0 10638 3145310
10,5 × 30,0 15052 3105300	9,8 × 30,3 10638 3098303	16,0 × 25,0 15052 3160250	14,3 × 20,3 10638 3143203
11,0 × 20,0 15052 3110200	10,5 × 31,0 10638 3105310	16,0 × 30,0 15052 3160300	15,0 × 21,0 10638 3150210
11,0 × 25,0 15052 3110250	10,8 × 21,3 10638 3108213	17,5 × 25,0 15052 3175250	14,3 × 25,3 10638 3143253
11,0 × 30,0 15052 3110300	11,5 × 22,0 10638 3115220	17,5 × 30,0 15052 3175300	15,0 × 26,0 10638 3150260
12,0 × 20,0 15052 3120200	10,8 × 25,3 10638 3108253	19,0 × 25,0 15052 3190250	14,3 × 30,3 10638 3143303
12,0 × 25,0 15052 3120250	11,5 × 26,0 10638 3115260	19,0 × 30,0 15052 3190300	15,0 × 31,0 10638 3150310
12,0 × 30,0 15052 3120300	10,8 × 30,3 10638 3108303	20,5 × 25,0 15052 3205250	16,3 × 25,3 10638 3163253
13,0 × 20,0 15052 3130200	11,5 × 31,0 10638 3115310	20,5 × 30,0 15052 3205300	17,0 × 26,0 10638 3170260
13,0 × 25,0 15052 3130250	11,3 × 20,3 10638 3113203	22,5 × 30,0 15052 3225300	16,3 × 30,3 10638 3163303
13,0 × 30,0 15052 3130300	12,0 × 21,0 10638 3120210	24,0 × 30,0 15052 3240300	17,0 × 31,0 10638 3170310
	11,3 × 25,3 10638 3113253	25,5 × 30,0 15052 3255300	17,8 × 25,3 10638 3178253
	12,0 × 26,0 10638 3120260		18,5 × 26,0 10638 3185260
	11,3 × 30,3 10638 3113303		17,8 × 30,3 10638 3178303
	12,0 × 31,0 10638 3120310		18,5 × 31,0 10638 3185310
	12,3 × 20,3 10638 3123203		19,3 × 25,3 10638 3193253
	13,0 × 21,0 10638 3130210		20,0 × 26,0 10638 3200260
	12,3 × 25,3 10638 3123253		19,3 × 30,3 10638 3193303
	13,0 × 26,0 10638 3130260		20,0 × 31,0 10638 3200310
	12,3 × 30,3 10638 3123303		20,8 × 25,3 10638 3208253
	13,0 × 31,0 10638 3130310		21,5 × 26,0 10638 3215260
	13,3 × 20,3 10638 3133203		20,8 × 30,3 10638 3208303
	14,0 × 21,0 10638 3140210		21,5 × 31,0 10638 3215310
	13,3 × 25,3 10638 3133253		22,8 × 30,3 10638 3228303
	14,0 × 26,0 10638 3140260		23,5 × 31,0 10638 3235310
	13,3 × 30,3 10638 3133303		24,3 × 30,3 10638 3243303
	14,0 × 31,0 10638 3140310		25,0 × 31,0 10638 3250310
			25,8 × 30,3 10638 3258303
			26,5 × 31,0 10638 3265310

MUBEA-Norm • MUBEA Style • Type MUBEA

Langlochstempel oblong punch poinçon oblong	Langlochmatrize oblong die matrice oblongue	Langlochstempel oblong punch poinçon oblong	Langlochmatrize oblong die matrice oblongue
Nr. 53	Nr. 39	Nr. 53	Nr. 39
MBN 50505-3	MBN 50639	MBN 50505-3	MBN 50639
Artikel-Nr.	Artikel-Nr.	Artikel-Nr.	Artikel-Nr.
11,0 × 35,0 15053 3110350	11,3 × 35,3 10639 3113353 12,0 × 36,0 10639 3120360	19,0 × 35,0 15053 3190350	19,3 × 35,3 10639 3193353 20,0 × 36,0 10639 3200360
11,0 × 40,0 15053 3110400	11,3 × 40,3 10639 3113403 12,0 × 41,0 10639 3120410	19,0 × 40,0 15053 3190400	19,3 × 40,3 10639 3193403 20,0 × 41,0 10639 3200410
13,5 × 35,0 15053 3135350	13,8 × 35,3 10639 3138353 14,5 × 36,0 10639 3145360	20,5 × 35,0 15053 3205350	20,8 × 35,3 10639 3208353 21,5 × 36,0 10639 3215360
13,5 × 40,0 15053 3135400	13,8 × 40,3 10639 3138403 14,5 × 41,0 10639 3145410	20,5 × 40,0 15053 3205400	20,8 × 40,3 10639 3208403 21,5 × 41,0 10639 3215410
14,0 × 35,0 15053 3140350	14,3 × 35,3 10639 3143353 15,0 × 36,0 10639 3150360	22,5 × 35,0 15053 3225350	22,8 × 35,3 10639 3228353 23,5 × 36,0 10639 3235360
14,0 × 40,0 15053 3140400	14,3 × 40,3 10639 3143403 15,0 × 41,0 10639 3150410	22,5 × 40,0 15053 3225400	22,8 × 40,3 10639 3228403 23,5 × 41,0 10639 3235410
16,0 × 35,0 15053 3160350	16,3 × 35,3 10639 3163353 17,0 × 36,0 10639 3170360	24,0 × 40,0 15053 3240400	24,3 × 40,3 10639 3243403 25,0 × 41,0 10639 3250410
16,0 × 40,0 15053 3160400	16,3×40,3 10639 3163403 17,0×41,0 10639 3170410	25,5 × 40,0 15053 3255400	25,8 × 40,3 10639 3258403 26,5 × 41,0 10639 3265410
17,5 × 35,0 15053 3175350	17,8×35,3 10639 3178353 18,5×36,0 10639 3185360	26,0 × 40,0 15053 3260400	26,3 × 40,3 10639 3263403 27,0 × 41,0 10639 3270410
17,5 × 40,0 15053 3175400	17,8×40,3 10639 3178403 18,5×41,0 10639 3185410	27,0 × 40,0 15053 3270400	27,3 × 40,3 10639 3273403 28,0 × 41,0 10639 3280410