



Peddinghaus

Peddinghaus Anlagen & Maschinen GmbH

Peddinghaus Anlagen & Maschinen GmbH
Hasslinghauser Str. 156 • D-58285 Gevelsberg
Tel. +49 (0) 2332 / 6646-20/21/22/23/24
Fax +49 (0) 2332 / 6646-46
teile-pam@peddy.de • www.peddy.de

Groene Serie

Voor modellen van de huidige generatie:

Peddicat 380 • 500

Peddimax 602 • 1002

Peddiworker 502 • 802

Hydraulic 280 • 502 • 1001

Voor oudere modellen :

Peddicat 361

Peddiworker 501 • 801 • 1000 G

Peddimaster 100/160 • 110/170 • 800/1100 • 1100/1700

Peddimax 600 • 601 • 800 • 801 • 110/140

Hydraulic 100 • 301 • 501 • 800 • 1000

210 Super 16 • 20 • 210 Standard 16

Forax 80 • 100 • 1000

225 B/ 16 • 20 • 80 • 100

225 H/ 15 • 20

Stempels en matrijzen voor snelwissel-inrichting

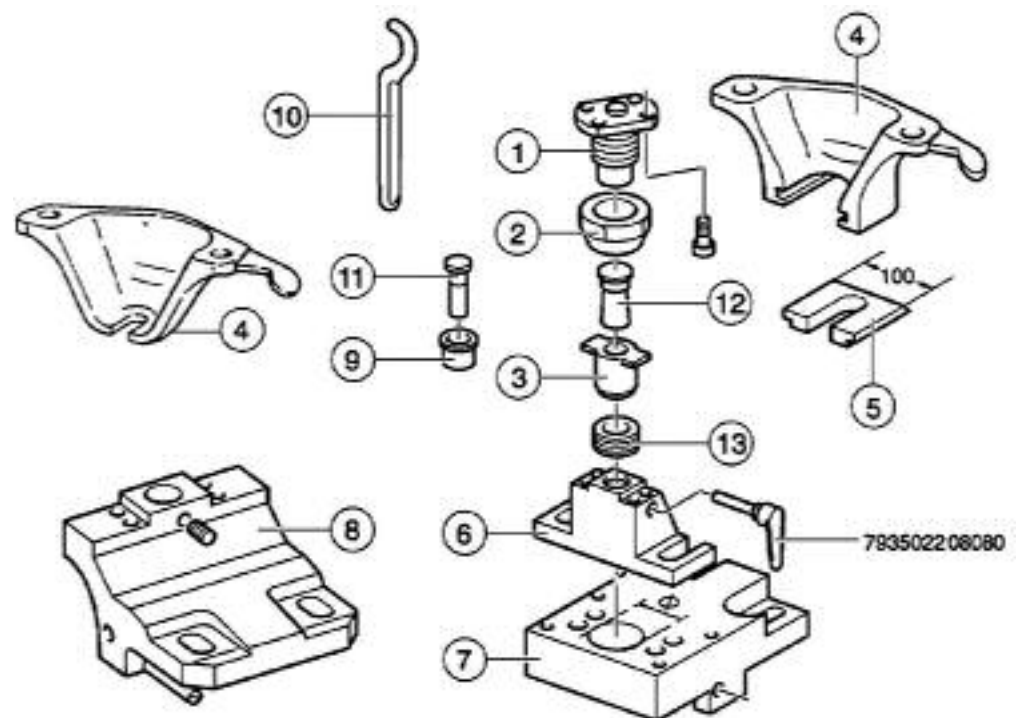



Groene Serie

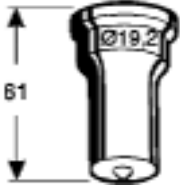
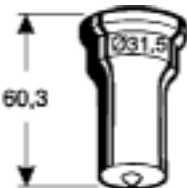
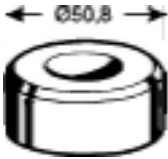
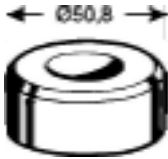
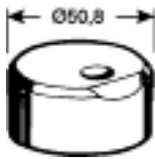







Rond stempel		Rond stempel		Rond matrijs		Rond matrijs		Excentrisch matrijs		
Nr. 2		Nr. 5		Nr. 3		Nr. 3		Nr. 14		
										
Bestelnr.	Bestelnr.	Bestelnr.	Bestelnr.	Bestelnr.	Bestelnr.	Bestelnr.	Bestelnr.	Bestelnr.	Bestelnr.	
3,0 64002 1030	17,5 64005 1175	3,2 64203 1032	20,2 64203 1202	5,7 64214 1057	3,2 64203 1034	20,7 64203 1207	6,2 64214 1062	3,4 64203 1037	21,2 64203 1212	6,7 64214 1067
3,5 64002 1035	18,0 64005 1180	3,7 64203 1037	21,2 64203 1212	7,2 64214 1072	4,2 64203 1042	21,7 64203 1217	7,7 64214 1077	4,4 64203 1044	22,2 64203 1222	8,2 64214 1082
4,0 64002 1040	18,5 64005 1185	4,7 64203 1047	22,2 64203 1222	8,7 64214 1087	4,5 64002 1045	22,7 64203 1227	8,7 64214 1087	5,2 64203 1052	23,2 64203 1232	9,2 64214 1092
4,2 64002 1042	19,0 64005 1190	5,2 64203 1052	23,2 64203 1232	9,7 64214 1097	6,0 64002 1060	23,7 64203 1237	9,7 64214 1097	5,7 64203 1057	24,2 64203 1242	10,2 64214 1102
4,5 64002 1045	19,5 64005 1195	6,2 64203 1062	24,2 64203 1242	10,7 64214 1107	6,5 64002 1065	24,7 64203 1247	10,7 64214 1107	6,2 64203 1062	25,2 64203 1252	10,7 64214 1107
5,0 64002 1050	20,0 64005 1200	6,7 64203 1067	25,2 64203 1252	11,2 64214 1112	7,0 64002 1070	25,7 64203 1257	11,2 64214 1112	6,7 64203 1067	26,2 64203 1262	11,7 64214 1117
5,5 64002 1055	20,5 64005 1205	7,2 64203 1072	26,2 64203 1262	12,2 64214 1122	7,5 64002 1075	26,7 64203 1267	12,2 64214 1122	7,2 64203 1072	27,2 64203 1272	12,7 64214 1127
6,0 64002 1060	21,0 64005 1210	7,7 64203 1077	27,2 64203 1272	13,2 64214 1132	8,0 64002 1080	27,7 64203 1277	13,2 64214 1132	7,7 64203 1077	28,2 64203 1277	13,7 64214 1137
6,5 64002 1065	21,5 64005 1215	8,2 64203 1082	28,2 64203 1282	14,2 64214 1142	8,5 64002 1085	28,7 64203 1287	14,2 64214 1142	8,2 64203 1082	29,2 64203 1292	14,7 64214 1147
7,0 64002 1070	22,0 64005 1220	8,7 64203 1087	29,2 64203 1292	15,2 64214 1152	9,0 64002 1090	29,7 64203 1297	15,2 64214 1152	8,7 64203 1087	30,2 64203 1302	15,7 64214 1157
7,5 64002 1075	22,5 64005 1225	9,2 64203 1092	30,2 64203 1302	16,2 64214 1162	9,5 64002 1095	30,7 64203 1307	16,2 64214 1162	9,2 64203 1092	31,2 64203 1312	16,7 64214 1167
8,0 64002 1080	23,0 64005 1230	9,7 64203 1097	31,2 64203 1312	17,2 64214 1172	10,0 64002 1100	31,7 64203 1317	17,2 64214 1172	9,7 64203 1097	32,2 64203 1322	17,7 64214 1177
8,5 64002 1085	23,5 64005 1235	10,2 64203 1102	32,2 64203 1322	18,2 64214 1182	10,5 64002 1105	32,7 64203 1327	18,2 64214 1182	10,2 64203 1102	33,2 64203 1332	18,7 64214 1187
9,0 64002 1090	24,0 64005 1240	10,7 64203 1107		19,2 64214 1187	11,0 64002 1110		19,2 64214 1187	10,7 64203 1107		19,7 64214 1192
9,5 64002 1095	24,5 64005 1245	11,2 64203 1112		20,2 64214 1192	11,5 64002 1115		20,2 64214 1192	11,2 64203 1112		20,7 64214 1197
10,0 64002 1100	25,0 64005 1250	11,7 64203 1117		21,2 64214 1202	12,0 64002 1120		21,2 64214 1202	11,7 64203 1117		21,7 64214 1207
10,5 64002 1105	25,5 64005 1255	12,2 64203 1122		22,2 64214 1212	12,5 64002 1125		22,2 64214 1212	12,2 64203 1122		22,7 64214 1217
11,0 64002 1110	26,0 64005 1260	12,7 64203 1127		23,2 64214 1222	13,0 64002 1130		23,2 64214 1222	12,7 64203 1127		23,7 64214 1227
11,5 64002 1115	26,5 64005 1265	13,2 64203 1132		24,2 64214 1232	13,5 64002 1135		24,2 64214 1232	13,2 64203 1132		24,7 64214 1237
12,0 64002 1120	27,0 64005 1270	13,7 64203 1137		25,2 64214 1242	14,0 64002 1140		25,2 64214 1242	13,7 64203 1137		25,7 64214 1247
12,5 64002 1125	27,5 64005 1275	14,2 64203 1142		26,2 64214 1252	14,5 64002 1145		26,2 64214 1252	14,2 64203 1142		26,7 64214 1257
13,0 64002 1130	28,0 64005 1280	14,7 64203 1147		27,2 64214 1262	15,0 64002 1150		27,2 64214 1262	14,7 64203 1147		27,7 64214 1267
13,5 64002 1135	28,5 64005 1285	15,2 64203 1152		28,2 64214 1272	15,5 64002 1155		28,2 64214 1272	15,2 64203 1152		28,7 64214 1277
14,0 64002 1140	29,0 64005 1290	15,7 64203 1157		29,2 64214 1282	16,0 64002 1160		29,2 64214 1282	15,7 64203 1157		29,7 64214 1287
14,5 64002 1145	29,5 64005 1295	16,2 64203 1162		30,2 64214 1292	16,5 64002 1165		30,2 64214 1292	16,2 64203 1162		30,7 64214 1297
15,0 64002 1150	30,0 64005 1300	16,7 64203 1167		31,2 64214 1302	17,0 64002 1170		31,2 64214 1302	16,7 64203 1167		31,7 64214 1307
15,5 64002 1155	30,5 64005 1305	17,2 64203 1172		32,2 64214 1312	17,5 64002 1175		32,2 64214 1312	17,2 64203 1172		32,7 64214 1317
16,0 64002 1160	31,0 64005 1310	17,7 64203 1177		33,2 64214 1322	18,0 64002 1180		33,2 64214 1322	17,7 64203 1177		
16,5 64002 1165	31,5 64005 1315	18,2 64203 1182			18,5 64002 1185			18,2 64203 1182		
17,0 64002 1170	32,0 64005 1320	18,7 64203 1187			19,0 64002 1190			18,7 64203 1187		
17,5 64002 1175		19,2 64203 1192						19,2 64203 1192		
18,0 64002 1180		19,7 64203 1197						19,7 64203 1197		
18,5 64002 1185										
19,0 64002 1190										

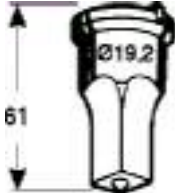

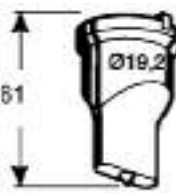
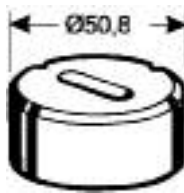
Reduceerhuls 2/5

44081 198 503

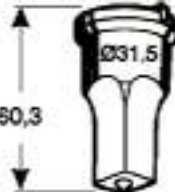

Groene Serie			
Vierkant stempel	Vierkant matrijs	Langgat stempel	Langgat matrijs
Nr. 2	Nr. 3	Nr. 2	Nr. 3
			
 Bestelnr.	 Bestelnr.	 Bestelnr.	 Bestelnr.
4,0 64002 2040 5,0 64002 2050 6,0 64002 2060 7,0 64002 2070 8,0 64002 2080 9,0 64002 2090 10,0 64002 2100 11,0 64002 2110 12,0 64002 2120 13,0 64002 2130	4,2 64203 2042 5,2 64203 2052 6,2 64203 2062 6,7 64203 2067 7,2 64203 2072 7,7 64203 2077 8,2 64203 2082 8,7 64203 2087 9,2 64203 2092 9,7 64203 2097 10,2 64203 2102 10,7 64203 2107 11,2 64203 2112 11,7 64203 2117 12,2 64203 2122 12,7 64203 2127 13,2 64203 2132 13,7 64203 2137 14,2 64203 2142 14,7 64203 2147 15,2 64203 2152 15,7 64203 2157 16,2 64203 2162 16,7 64203 2167 17,2 64203 2172 17,7 64203 2177 18,2 64203 2182 18,7 64203 2187 19,2 64203 2192 19,7 64203 2197 20,2 64203 2202 20,7 64203 2207 21,2 64203 2212 21,7 64203 2217 22,2 64203 2222 22,7 64203 2227 23,2 64203 2232 23,7 64203 2237	5,0 x 10,0 64002 3 050100 5,0 x 14,0 64002 3 050140 5,5 x 10,0 64002 3 055100 5,5 x 14,0 64002 3 055140 5,5 x 19,0 64002 3 055190 6,5 x 12,0 64002 3 065120 6,5 x 18,0 64002 3 065180 7,5 x 14,0 64002 3 075140 9,0 x 14,0 64002 3 090140 9,0 x 18,0 64002 3 090180 10,0 x 14,0 64002 3 100140	5,2 x 10,2 64203 3 052102 5,7 x 10,7 64203 3 057107 5,2 x 14,2 64203 3 052142 5,7 x 14,7 64203 3 057147 5,7 x 10,2 64203 3 057102 6,2 x 10,7 64203 3 062107 5,7 x 14,2 64203 3 057142 6,2 x 14,7 64203 3 062147 5,7 x 19,2 64203 3 057192 6,2 x 19,7 64203 3 062197 6,7 x 12,2 64203 3 067122 7,2 x 12,7 64203 3 072127 6,7 x 18,2 64203 3 067182 7,2 x 18,7 64203 3 072187 7,7 x 14,2 64203 3 077142 8,2 x 14,7 64203 3 082147 9,2 x 14,2 64203 3 092142 9,7 x 14,7 64203 3 097147 9,2 x 18,2 64203 3 092182 9,7 x 18,7 64203 3 097187 10,2 x 14,2 64203 3 102142 10,7 x 14,7 64203 3 107147 11,2 x 15,2 64203 3 112152
Vierkant stempel			
Nr. 5			
			
 Bestelnr.			
14,0 64005 2140 15,0 64005 2150 16,0 64005 2160 17,0 64005 2170 18,0 64005 2180 19,0 64005 2190 20,0 64005 2200 21,0 64005 2210 22,0 64005 2220			
			Snijspeling: Materiaaldikte: 0,2 mm tot 4 mm 0,7 mm 4 tot 9 mm 1,2 mm 9 tot 14 mm

Groene Serie

Langgat stempel		Langgat matrijs		Langgat stempel		Langgat matrijs	
Nr. 5		Nr. 3		Nr. 5		Nr. 3	
Bestelnr.	Bestelnr.	Bestelnr.	Bestelnr.	Bestelnr.	Bestelnr.	Bestelnr.	Bestelnr.
5,5 x 25,0 64005 3 055250	5,7 x 25,2 64203 3 057252	12,0 x 24,0 64005 3 120240	6,2 x 25,7 64203 3 062257	12,0 x 24,0 64005 3 120240	12,2 x 24,2 64203 3 122242	12,7 x 24,7 64203 3 127247	13,2 x 25,2 64203 3 132252
6,5 x 26,0 64005 3 065260	6,7 x 26,2 64203 3 067262	12,0 x 30,0 64005 3 120300	7,2 x 26,7 64203 3 072267	12,0 x 30,0 64005 3 120300	12,2 x 30,2 64203 3 122302	12,7 x 30,7 64203 3 127307	13,2 x 31,2 64203 3 132312
6,5 x 30,0 64005 3 065300	6,7 x 30,2 64203 3 067302	13,0 x 26,0 64005 3 130260	7,2 x 30,7 64203 3 072307	13,0 x 26,0 64005 3 130260	13,2 x 26,2 64203 3 132262	13,7 x 26,7 64203 3 137267	14,2 x 27,2 64203 3 142272
7,5 x 21,0 64005 3 075210	7,7 x 21,2 64203 3 077212	13,0 x 30,0 64005 3 130300	8,2 x 21,7 64203 3 082217	13,0 x 30,0 64005 3 130300	13,2 x 30,2 64203 3 132302	13,7 x 30,7 64203 3 137307	14,2 x 31,2 64203 3 142312
7,5 x 26,0 64005 3 075260	7,7 x 26,2 64203 3 077262	14,0 x 26,0 64005 3 140260	8,2 x 26,7 64203 3 082267	14,0 x 26,0 64005 3 140260	14,2 x 26,2 64203 3 142262	14,7 x 26,7 64203 3 147267	15,2 x 27,2 64203 3 152272
7,5 x 30,0 64005 3 075300	7,7 x 30,2 64203 3 077302	14,0 x 28,0 64005 3 140280	8,2 x 30,7 64203 3 082307	14,0 x 28,0 64005 3 140280	14,2 x 28,2 64203 3 142282	14,7 x 28,7 64203 3 147287	15,2 x 29,2 64203 3 152292
9,0 x 26,0 64005 3 090260	9,2 x 26,2 64203 3 092262	16,0 x 26,0 64005 3 160260	9,7 x 26,7 64203 3 097267	16,0 x 26,0 64005 3 160260	16,2 x 26,2 64203 3 162262	16,7 x 26,7 64203 3 167267	17,2 x 27,2 64203 3 172272
9,0 x 30,0 64005 3 090300	9,2 x 30,2 64203 3 092302	16,0 x 31,0 64005 3 160310	9,7 x 30,7 64203 3 097307	16,0 x 31,0 64005 3 160310	16,2 x 31,2 64203 3 162312	16,7 x 31,7 64203 3 167317	17,2 x 32,2 64203 3 172322
10,0 x 20,0 64005 3 100200	10,2 x 20,2 64203 3 102202	18,0 x 26,0 64005 3 180260	10,7 x 20,7 64203 3 107207	18,0 x 26,0 64005 3 180260	16,2 x 26,2 64203 3 162262	16,7 x 26,7 64203 3 167267	17,2 x 27,2 64203 3 172272
10,0 x 26,0 64005 3 100260	10,2 x 26,2 64203 3 102262	18,0 x 31,0 64005 3 180310	10,7 x 26,7 64203 3 107267	18,0 x 31,0 64005 3 180310	16,2 x 31,2 64203 3 162312	16,7 x 31,7 64203 3 167317	17,2 x 32,2 64203 3 172322
10,0 x 30,0 64005 3 100300	10,2 x 30,2 64203 3 102302	20,0 x 31,0 64005 3 200310	10,7 x 30,7 64203 3 107307	20,0 x 31,0 64005 3 200310	16,2 x 31,2 64203 3 162312	16,7 x 31,7 64203 3 167317	17,2 x 32,2 64203 3 172322
11,0 x 22,0 64005 3 110220	11,2 x 22,2 64203 3 112222	22,0 x 31,0 64005 3 220310	11,2 x 22,7 64203 3 112227	22,0 x 31,0 64005 3 220310	18,2 x 26,2 64203 3 182262	18,7 x 26,7 64203 3 187267	19,2 x 27,2 64203 3 192272
11,0 x 26,0 64005 3 110260	11,2 x 26,2 64203 3 112262		11,2 x 23,2 64203 3 112232		18,2 x 31,2 64203 3 182312	18,7 x 31,7 64203 3 187317	19,2 x 32,2 64203 3 192322
11,0 x 30,0 64005 3 110300	11,2 x 30,2 64203 3 112302		11,7 x 26,7 64203 3 117267		18,2 x 31,2 64203 3 182312	18,7 x 31,7 64203 3 187317	19,2 x 32,2 64203 3 192322
	11,7 x 30,7 64203 3 117307		12,2 x 27,2 64203 3 122272		20,2 x 31,2 64203 3 202312	20,7 x 31,7 64203 3 207317	21,2 x 32,2 64203 3 212322
	12,2 x 31,2 64203 3 122312				22,2 x 31,2 64203 3 222312	22,7 x 31,7 64203 3 227317	23,2 x 32,2 64203 3 232322

Snijspeling: **0,2 mm** (Materiaaldikte: tot 4 mm) • **0,7 mm** (Materiaaldikte: 4 tot 9 mm) • **1,2 mm** (Materiaaldikte: 9 tot 14 mm)



Peddinghaus Anlagen & Maschinen GmbH

Peddinghaus Anlagen & Maschinen GmbH
 Hasslinghauser Str. 156 • D-58285 Gevelsberg
 Tel. +49 (0) 2332 / 6646-20/21/22/23/24
 Fax +49 (0) 2332 / 6646-46
 teile-pam@peddy.de • www.peddy.de

Groene Serie			
Langgat stempel	Langgat stempel	Excentrisch matrijs langgat langs	Excentrisch matrijs langgat dwars
Nr. 2	Nr. 5	Nr. 14	Nr. 14
Bestelnr.	Bestelnr.	Bestelnr.	Bestelnr.
5,5 x 14,0 64002 3 055140	5,5 x 25,0 64005 3 055250	6,2 x 14,7 64214 3 062147	6,2 x 14,7 64214 4 062147
	6,5 x 26,0 64005 3 065260	6,2 x 25,7 64214 3 062257	6,2 x 25,7 64214 4 062257
	7,5 x 26,0 64005 3 075260	7,2 x 26,7 64214 3 072267	7,2 x 26,7 64214 4 072267
9,0 x 14,0 64002 3 090140		8,2 x 26,7 64214 3 082267	8,2 x 26,7 64214 4 082267
	9,0 x 26,0 64005 3 090260	9,7 x 14,7 64214 3 097147	9,7 x 14,7 64214 4 097147
	10,0 x 20,0 64005 3 100200	9,7 x 26,7 64214 3 097267	9,7 x 26,7 64214 4 097267
	11,0 x 22,0 64005 3 110220	10,7 x 20,7 64214 3 107207	10,7 x 20,7 64214 4 107207
	11,0 x 26,0 64005 3 110260	11,7 x 22,7 64214 3 117227	11,7 x 22,7 64214 4 117227
	13,0 x 26,0 64005 3 130260	11,7 x 26,7 64214 3 117267	11,7 x 26,7 64214 4 117267
	14,0 x 26,0 64005 3 140260	13,7 x 26,7 64214 3 137267	13,7 x 26,7 64214 4 137267
	16,0 x 26,0 64005 3 160260	14,7 x 26,7 64214 3 147267	14,7 x 26,7 64214 4 147267
		16,7 x 26,7 64214 3 167267	16,7 x 26,7 64214 4 167267

Groene Serie

Rechthoek stempel		Rechthoek matrijs		Sleutelgat stempel*		Sleutelgat matrijs	
Nr. 5		Nr. 3		Nr. 5		Nr. 3	
	Bestelnr.		Bestelnr.		Bestelnr.		Bestelnr.
5,0x15	64005 5 050150	5,2x15,2	64203 5 052152	34,0 x Ø17,5 x 10,5	65005 17 001	34,2 x Ø17,7 x 10,7	65203 17 001
5,0x20	64005 5 050200	5,7x15,7	64203 5 057157				
6,0x24	64005 5 060240	5,2x20,2	64203 5 052202	* Hiervoor is nodig: Snelspanzet - sleutelgat Bestelnr. 42217 6 2002 02			
8,0x16	64005 5 080160	5,7x20,7	64203 5 057207				
8,0x24	64005 5 080240	6,2x24,2	64203 5 062242	tbv stempel-snelwissel-inrichting – groene serie – v. a. 1993			
9,0x24	64005 5 090240	6,7x24,7	64203 5 067247				
10,0x20	64005 5 100200	8,2x16,2	64203 5 082162				
11,0x22	64005 5 110220	8,7x16,7	64203 5 087167				
12,0x22	64005 5 120220	8,2x24,2	64203 5 082242				
12,0x30	64005 5 120300	8,7x24,7	64203 5 087247				
14,0x20	64005 5 140200	9,2x24,2	64203 5 092242				
16,0x20	64005 5 160200	9,7x24,7	64203 5 097247				
		10,2x20,2	64203 5 102202				
		10,7x20,7	64203 5 107207				
		11,2x22,2	64203 5 112222				
		11,7x22,7	64203 5 117227				
		12,2x22,2	64203 5 122222				
		12,7x22,7	64203 5 127227				
		12,2x30,2	64203 5 122302				
		12,7x30,7	64203 5 127307				
		14,2x20,2	64203 5 142202				
		14,7x20,7	64203 5 147207				
		16,2x20,2	64203 5 162202				
		16,7x20,7	64203 5 167207				
Hoekafrond stempel		Hoekafrond matrijs		Spanjolet stempel		Spanjolet matrijs	
Nr. 5		Nr. 3		Nr. 5		Nr. 3	
	Bestelnr.		Bestelnr.		Bestelnr.		Bestelnr.
Radius		Radius		Ø 22,2x20,3	65005 38 222203	Ø 22,4 x20,5	65203 38 224205
5	65005 37 00050	5	65203 37 00050				
10	65005 37 00100	10	65203 37 00100				
15	65005 37 00150	14	65203 37 00140				
		15	65203 37 00150				



Groene Serie

Speciale stempels voor ponsen in RVS

Rond stempel, speciaal

Nr. 2



Bestelnr.

3,0	P-65002 8012 030
4,0	P-65002 8012 040
5,0	P-65002 8012 050
5,5	P-65002 8012 055
6,0	P-65002 8012 060
6,5	P-65002 8012 065
7,0	P-65002 8012 070
8,0	P-65002 8012 080
9,0	P-65002 8012 090
10,0	P-65002 8012 100
11,0	P-65002 8012 110
12,0	P-65002 8012 120
13,0	P-65002 8012 130
14,0	P-65002 8012 140
15,0	P-65002 8012 150
16,0	P-65002 8012 160
17,0	P-65002 8012 170

Rond matrjjs (standaard)

Nr. 3



Bestelnr.

3,2	64203 1032
3,7	64203 1037
4,2	64203 1042
4,7	64203 1047
5,2	64203 1052
5,7	64203 1057
6,2	64203 1062
6,7	64203 1067
7,2	64203 1072
7,7	64203 1077
8,2	64203 1082
8,7	64203 1087
9,2	64203 1092
9,7	64203 1097
10,2	64203 1102
10,7	64203 1107

Rond matrjjs (standaard)

Nr. 3

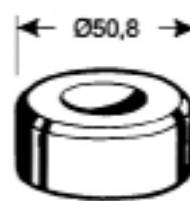

Bestelnr.

11,2	64203 1112
11,7	64203 1117
12,2	64203 1122
12,7	64203 1127
13,2	64203 1132
13,7	64203 1137
14,2	64203 1142
14,7	64203 1147
15,2	64203 1152
15,7	64203 1157
16,2	64203 1162
16,7	64203 1167
17,2	64203 1172
17,7	64203 1177
18,2	64203 1182

Vierkant stempel, speciaal

Nr. 2

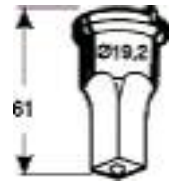

Bestelnr.

9,0	P-65002 8014 090
-----	------------------

Vierkant matrjjs (standaard)

Nr. 3



Bestelnr.

9,7	64203 2097
-----	------------

Langgat stempel, speciaal

Nr. 2

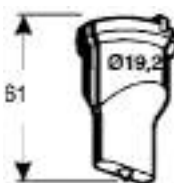

Bestelnr.

5,1x10,0	P-65002 8013 02
9,0x14,0	P-65002 8013 01
9,0x18,0	P-65002 8013 03

Langgat matrjjs (standaard)

Nr. 3

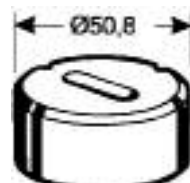

Bestelnr.

9,7x14,7	64203 3 097147
9,7x18,7	64203 3 097187

Langgat stempel, speciaal

Nr. 5

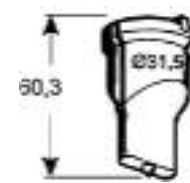

Bestelnr.

9,0x25,0	P-65005 8024 02
10,0x30,0	P-65005 8024 01
11,0x26,0	P-65005 8024 04
11,0x30,0	P-65005 8024 03

Langgat matrjjs (standaard)

Nr. 3

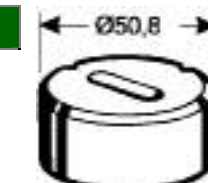

Bestelnr.

9,7x25,7	64203 3 097257
10,7x30,7	64203 3 107307
11,2x31,2	64203 3 112312
11,7x26,7	64203 3 117267
12,2x27,2	64203 3 122272
11,7x30,7	64203 3 117307
12,2x31,2	64203 3 122312