



Peddinghaus

Peddinghaus Anlagen & Maschinen GmbH

Peddinghaus Española, S.A.
Pol. Ind. Gojain
01170 Legutiano - Alava - España
tel. +34 945 46 53 70
fax +34 945 46 55 26
pesa@peddinghaus.es • www.peddy.de

Serie Roja

para las máquinas de catálogos antiguos :

Peddicat 360

Peddiworker 400 • 500 • 600 • 800

Peddimaster 450M • 28/40 • 40/60 • 60/80 • 60/100 • 80/110

Hydraulic 28 • 40 • 60N • 300 • 400 • 500 • 600

210 Super/Standard 11 • 13

Forax 15 • 25 • 45 • 65 • 150 • 250 • 450

Stanzfix

225 B/ 11 • 13 • 45 • 60

225 H/ 11 • 13

Punzones y matrices para el dispositivo de cambio rápido de punzonado

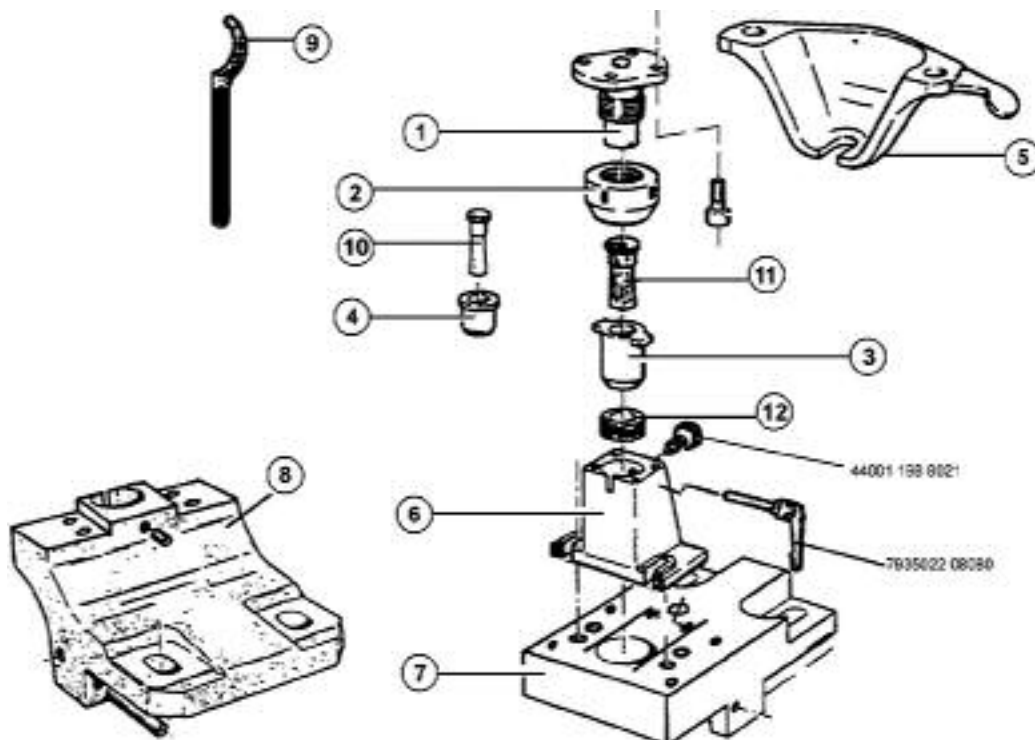



Peddinghaus





Peddinghaus Anlagen & Maschinen GmbH

Peddinghaus Española, S.A.
 Pol. Ind. Gojain
 01170 Legutiano - Alava - España
 tel. +34 945 46 53 70
 fax +34 945 46 55 26
 pesa@peddinghaus.es • www.peddy.de

Serie Roja				
punzón redondo	punzón redondo	matriz redonda	matriz redonda	matriz redonda descentrada
No 1	No 4	No 2	No 2	No 13
N° referencia	N° referencia	N° referencia	N° referencia	N° referencia
3,0 64001 1030 3,2 64001 1032 3,5 64001 1035 4,0 64001 1040 4,2 64001 1042 4,5 64001 1045 5,0 64001 1050 5,5 64001 1055 6,0 64001 1060 6,5 64001 1065 7,0 64001 1070 7,5 64001 1075 8,0 64001 1080 8,5 64001 1085 9,0 64001 1090 9,5 64001 1095 10,0 64001 1100 10,5 64001 1105 11,0 64001 1110 11,5 64001 1115 12,0 64001 1120 12,5 64001 1125 13,0 64001 1130 13,5 64001 1135 14,0 64001 1140	8,0 64004 1080 8,5 64004 1085 9,0 64004 1090 9,5 64004 1095 10,0 64004 1100 10,5 64004 1105 11,0 64004 1110 11,5 64004 1115 12,0 64004 1120 12,5 64004 1125 13,0 64004 1130 13,5 64004 1135 14,0 64004 1140 14,5 64004 1145 15,0 64004 1150 15,5 64004 1155 16,0 64004 1160 16,5 64004 1165 17,0 64004 1170 17,5 64004 1175 18,0 64004 1180 18,5 64004 1185 19,0 64004 1190 19,5 64004 1195 20,0 64004 1200 20,5 64004 1205 21,0 64004 1210 21,5 64004 1215 22,0 64004 1220 22,5 64004 1225 23,0 64004 1230 23,5 64004 1235 24,0 64004 1240 24,5 64004 1245 25,0 64004 1250 25,5 64004 1255 26,0 64004 1260 26,5 64004 1265 27,0 64004 1270	3,2 64202 1032 3,4 64202 1034 3,7 64202 1037 4,2 64202 1042 4,4 64202 1044 4,7 64202 1047 5,2 64202 1052 5,7 64202 1057 6,2 64202 1062 6,7 64202 1067 7,2 64202 1072 7,7 64202 1077 8,2 64202 1082 8,7 64202 1087 9,2 64202 1092 9,7 64202 1097 10,2 64202 1102 10,7 64202 1107 11,2 64202 1112 11,7 64202 1117 12,2 64202 1122 12,7 64202 1127 13,2 64202 1132 13,7 64202 1137 14,2 64202 1142 14,7 64202 1147 15,2 64202 1152 15,7 64202 1157 16,2 64202 1162 16,7 64202 1167 17,2 64202 1172 17,7 64202 1177 18,2 64202 1182 18,7 64202 1187	19,2 64202 1192 19,7 64202 1197 20,2 64202 1202 20,7 64202 1207 21,2 64202 1212 21,7 64202 1217 22,2 64202 1222 22,7 64202 1227 23,2 64202 1232 23,7 64202 1237 24,2 64202 1242 24,7 64202 1247 25,2 64202 1252 25,7 64202 1257 26,2 64202 1262 26,7 64202 1267 27,2 64202 1272 27,7 64202 1277 28,2 64202 1282 28,7 64202 1287 29,2 64202 1292 29,7 64202 1297 30,2 64202 1302 30,7 64202 1307	5,2 64213 1052 5,7 64213 1057 6,2 64213 1062 6,7 64213 1067 7,2 64213 1072 7,7 64213 1077 8,2 64213 1082 8,7 64213 1087 9,2 64213 1092 9,7 64213 1097 10,2 64213 1102 10,7 64213 1107 11,2 64213 1112 11,7 64213 1117 12,2 64213 1122 12,7 64213 1127 13,2 64213 1132 13,7 64213 1137 14,2 64213 1142 14,7 64213 1147 15,2 64213 1152 15,7 64213 1157 16,2 64213 1162 16,7 64213 1167 17,2 64213 1172 17,7 64213 1177 18,2 64213 1182 18,7 64213 1187 19,2 64213 1192 19,7 64213 1197 20,2 64213 1202 20,7 64213 1207 21,2 64213 1212 21,7 64213 1217 22,2 64213 1222 22,7 64213 1227
 manguito de reducción 1/4 44001 198 503	28,0* 64004 1280 29,0* 64004 1290 30,0* 64004 1300	*gran tamaño - para punzón de gran tamaño, tambien es necesario: tensor rápido 44001 6 3523 01		

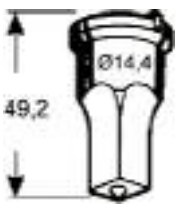

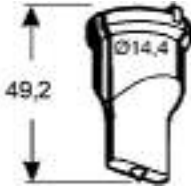
Serie Roja

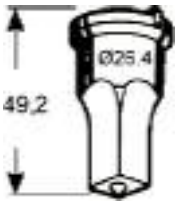
Serie Roja																																																																																																																																					
punzón cuadrado	matriz cuadrada	punzón ovalado	matriz ovalada																																																																																																																																		
<div style="background-color: #800000; color: white; padding: 2px; margin-bottom: 5px;">No 1</div> 	<div style="background-color: #800000; color: white; padding: 2px; margin-bottom: 5px;">No 2</div> 	<div style="background-color: #800000; color: white; padding: 2px; margin-bottom: 5px;">No 1</div> 	<div style="background-color: #800000; color: white; padding: 2px; margin-bottom: 5px;">No 2</div> 																																																																																																																																		
N° referencia	N° referencia	N° referencia	N° referencia																																																																																																																																		
<table style="width: 100%; border-collapse: collapse;"> <tr><td style="padding: 2px;">4,0</td><td style="padding: 2px;">64001 2040</td></tr> <tr><td style="padding: 2px;">5,0</td><td style="padding: 2px;">64001 2050</td></tr> <tr><td style="padding: 2px;">6,0</td><td style="padding: 2px;">64001 2060</td></tr> <tr><td style="padding: 2px;">7,0</td><td style="padding: 2px;">64001 2070</td></tr> <tr><td style="padding: 2px;">8,0</td><td style="padding: 2px;">64001 2080</td></tr> <tr><td style="padding: 2px;">9,0</td><td style="padding: 2px;">64001 2090</td></tr> <tr><td style="padding: 2px;">10,0</td><td style="padding: 2px;">64001 2100</td></tr> </table>	4,0	64001 2040	5,0	64001 2050	6,0	64001 2060	7,0	64001 2070	8,0	64001 2080	9,0	64001 2090	10,0	64001 2100	<table style="width: 100%; border-collapse: collapse;"> <tr><td style="padding: 2px;">4,2</td><td style="padding: 2px;">64202 2042</td></tr> <tr><td style="padding: 2px;">5,2</td><td style="padding: 2px;">64202 2052</td></tr> <tr><td style="padding: 2px;">6,2</td><td style="padding: 2px;">64202 2062</td></tr> <tr><td style="padding: 2px;">6,7</td><td style="padding: 2px;">64202 2067</td></tr> <tr><td style="padding: 2px;">7,2</td><td style="padding: 2px;">64202 2072</td></tr> <tr><td style="padding: 2px;">7,7</td><td style="padding: 2px;">64202 2077</td></tr> <tr><td style="padding: 2px;">8,2</td><td style="padding: 2px;">64202 2082</td></tr> <tr><td style="padding: 2px;">8,7</td><td style="padding: 2px;">64202 2087</td></tr> <tr><td style="padding: 2px;">9,2</td><td style="padding: 2px;">64202 2092</td></tr> <tr><td style="padding: 2px;">9,7</td><td style="padding: 2px;">64202 2097</td></tr> <tr><td style="padding: 2px;">10,2</td><td style="padding: 2px;">64202 2102</td></tr> <tr><td style="padding: 2px;">10,7</td><td style="padding: 2px;">64202 2107</td></tr> <tr><td style="padding: 2px;">11,2</td><td style="padding: 2px;">64202 2112</td></tr> <tr><td style="padding: 2px;">11,7</td><td style="padding: 2px;">64202 2117</td></tr> <tr><td style="padding: 2px;">12,2</td><td style="padding: 2px;">64202 2122</td></tr> <tr><td style="padding: 2px;">12,7</td><td style="padding: 2px;">64202 2127</td></tr> <tr><td style="padding: 2px;">13,2</td><td style="padding: 2px;">64202 2132</td></tr> <tr><td style="padding: 2px;">13,7</td><td style="padding: 2px;">64202 2137</td></tr> <tr><td style="padding: 2px;">14,2</td><td style="padding: 2px;">64202 2142</td></tr> <tr><td style="padding: 2px;">14,7</td><td style="padding: 2px;">64202 2147</td></tr> <tr><td style="padding: 2px;">15,2</td><td style="padding: 2px;">64202 2152</td></tr> <tr><td style="padding: 2px;">15,7</td><td style="padding: 2px;">64202 2157</td></tr> <tr><td style="padding: 2px;">16,2</td><td style="padding: 2px;">64202 2162</td></tr> <tr><td style="padding: 2px;">16,7</td><td style="padding: 2px;">64202 2167</td></tr> <tr><td style="padding: 2px;">17,2</td><td style="padding: 2px;">64202 2172</td></tr> <tr><td style="padding: 2px;">17,7</td><td style="padding: 2px;">64202 2177</td></tr> <tr><td style="padding: 2px;">18,2</td><td style="padding: 2px;">64202 2182</td></tr> <tr><td style="padding: 2px;">18,7</td><td style="padding: 2px;">64202 2187</td></tr> <tr><td style="padding: 2px;">19,2</td><td style="padding: 2px;">64202 2192</td></tr> <tr><td style="padding: 2px;">19,7</td><td style="padding: 2px;">64202 2197</td></tr> <tr><td style="padding: 2px;">20,2</td><td style="padding: 2px;">64202 2202</td></tr> <tr><td style="padding: 2px;">20,7</td><td style="padding: 2px;">64202 2207</td></tr> <tr><td style="padding: 2px;">21,2</td><td style="padding: 2px;">64202 2212</td></tr> <tr><td style="padding: 2px;">21,7</td><td style="padding: 2px;">64202 2217</td></tr> </table>	4,2	64202 2042	5,2	64202 2052	6,2	64202 2062	6,7	64202 2067	7,2	64202 2072	7,7	64202 2077	8,2	64202 2082	8,7	64202 2087	9,2	64202 2092	9,7	64202 2097	10,2	64202 2102	10,7	64202 2107	11,2	64202 2112	11,7	64202 2117	12,2	64202 2122	12,7	64202 2127	13,2	64202 2132	13,7	64202 2137	14,2	64202 2142	14,7	64202 2147	15,2	64202 2152	15,7	64202 2157	16,2	64202 2162	16,7	64202 2167	17,2	64202 2172	17,7	64202 2177	18,2	64202 2182	18,7	64202 2187	19,2	64202 2192	19,7	64202 2197	20,2	64202 2202	20,7	64202 2207	21,2	64202 2212	21,7	64202 2217	<table style="width: 100%; border-collapse: collapse;"> <tr><td style="padding: 2px;">5,0x10</td><td style="padding: 2px;">64001 3050100</td></tr> <tr><td style="padding: 2px;">5,0x14</td><td style="padding: 2px;">64001 3050140</td></tr> <tr><td style="padding: 2px;">5,5x10</td><td style="padding: 2px;">64001 3055100</td></tr> <tr><td style="padding: 2px;">5,5x14</td><td style="padding: 2px;">64001 3055140</td></tr> <tr><td style="padding: 2px;">6,5x12</td><td style="padding: 2px;">64001 3065120</td></tr> <tr><td style="padding: 2px;">7,5x14</td><td style="padding: 2px;">64001 3075140</td></tr> <tr><td style="padding: 2px;">9,0x14</td><td style="padding: 2px;">64001 3090140</td></tr> <tr><td style="padding: 2px;">10,0x14</td><td style="padding: 2px;">64001 3100140</td></tr> </table>	5,0x10	64001 3050100	5,0x14	64001 3050140	5,5x10	64001 3055100	5,5x14	64001 3055140	6,5x12	64001 3065120	7,5x14	64001 3075140	9,0x14	64001 3090140	10,0x14	64001 3100140	<table style="width: 100%; border-collapse: collapse;"> <tr><td style="padding: 2px;">5,2 x 10,2</td><td style="padding: 2px;">64202 3 052102</td></tr> <tr><td style="padding: 2px;">5,7 x 10,7</td><td style="padding: 2px;">64202 3 057107</td></tr> <tr><td style="padding: 2px;">5,2 x 14,2</td><td style="padding: 2px;">64202 3 052142</td></tr> <tr><td style="padding: 2px;">5,7 x 14,7</td><td style="padding: 2px;">64202 3 057147</td></tr> <tr><td style="padding: 2px;">5,7 x 10,2</td><td style="padding: 2px;">64202 3 057102</td></tr> <tr><td style="padding: 2px;">6,2 x 10,7</td><td style="padding: 2px;">64202 3 062107</td></tr> <tr><td style="padding: 2px;">5,7 x 14,2</td><td style="padding: 2px;">64202 3 057142</td></tr> <tr><td style="padding: 2px;">6,2 x 14,7</td><td style="padding: 2px;">64202 3 062147</td></tr> <tr><td style="padding: 2px;">6,7 x 12,2</td><td style="padding: 2px;">64202 3 067122</td></tr> <tr><td style="padding: 2px;">7,2 x 12,7</td><td style="padding: 2px;">64202 3 072127</td></tr> <tr><td style="padding: 2px;">7,7 x 14,2</td><td style="padding: 2px;">64202 3 077142</td></tr> <tr><td style="padding: 2px;">8,2 x 14,7</td><td style="padding: 2px;">64202 3 082147</td></tr> <tr><td style="padding: 2px;">9,2 x 14,2</td><td style="padding: 2px;">64202 3 092142</td></tr> <tr><td style="padding: 2px;">9,7 x 14,7</td><td style="padding: 2px;">64202 3 097147</td></tr> <tr><td style="padding: 2px;">10,2 x 14,2</td><td style="padding: 2px;">64202 3 102142</td></tr> <tr><td style="padding: 2px;">10,7 x 14,7</td><td style="padding: 2px;">64202 3 107147</td></tr> </table>	5,2 x 10,2	64202 3 052102	5,7 x 10,7	64202 3 057107	5,2 x 14,2	64202 3 052142	5,7 x 14,7	64202 3 057147	5,7 x 10,2	64202 3 057102	6,2 x 10,7	64202 3 062107	5,7 x 14,2	64202 3 057142	6,2 x 14,7	64202 3 062147	6,7 x 12,2	64202 3 067122	7,2 x 12,7	64202 3 072127	7,7 x 14,2	64202 3 077142	8,2 x 14,7	64202 3 082147	9,2 x 14,2	64202 3 092142	9,7 x 14,7	64202 3 097147	10,2 x 14,2	64202 3 102142	10,7 x 14,7	64202 3 107147
4,0	64001 2040																																																																																																																																				
5,0	64001 2050																																																																																																																																				
6,0	64001 2060																																																																																																																																				
7,0	64001 2070																																																																																																																																				
8,0	64001 2080																																																																																																																																				
9,0	64001 2090																																																																																																																																				
10,0	64001 2100																																																																																																																																				
4,2	64202 2042																																																																																																																																				
5,2	64202 2052																																																																																																																																				
6,2	64202 2062																																																																																																																																				
6,7	64202 2067																																																																																																																																				
7,2	64202 2072																																																																																																																																				
7,7	64202 2077																																																																																																																																				
8,2	64202 2082																																																																																																																																				
8,7	64202 2087																																																																																																																																				
9,2	64202 2092																																																																																																																																				
9,7	64202 2097																																																																																																																																				
10,2	64202 2102																																																																																																																																				
10,7	64202 2107																																																																																																																																				
11,2	64202 2112																																																																																																																																				
11,7	64202 2117																																																																																																																																				
12,2	64202 2122																																																																																																																																				
12,7	64202 2127																																																																																																																																				
13,2	64202 2132																																																																																																																																				
13,7	64202 2137																																																																																																																																				
14,2	64202 2142																																																																																																																																				
14,7	64202 2147																																																																																																																																				
15,2	64202 2152																																																																																																																																				
15,7	64202 2157																																																																																																																																				
16,2	64202 2162																																																																																																																																				
16,7	64202 2167																																																																																																																																				
17,2	64202 2172																																																																																																																																				
17,7	64202 2177																																																																																																																																				
18,2	64202 2182																																																																																																																																				
18,7	64202 2187																																																																																																																																				
19,2	64202 2192																																																																																																																																				
19,7	64202 2197																																																																																																																																				
20,2	64202 2202																																																																																																																																				
20,7	64202 2207																																																																																																																																				
21,2	64202 2212																																																																																																																																				
21,7	64202 2217																																																																																																																																				
5,0x10	64001 3050100																																																																																																																																				
5,0x14	64001 3050140																																																																																																																																				
5,5x10	64001 3055100																																																																																																																																				
5,5x14	64001 3055140																																																																																																																																				
6,5x12	64001 3065120																																																																																																																																				
7,5x14	64001 3075140																																																																																																																																				
9,0x14	64001 3090140																																																																																																																																				
10,0x14	64001 3100140																																																																																																																																				
5,2 x 10,2	64202 3 052102																																																																																																																																				
5,7 x 10,7	64202 3 057107																																																																																																																																				
5,2 x 14,2	64202 3 052142																																																																																																																																				
5,7 x 14,7	64202 3 057147																																																																																																																																				
5,7 x 10,2	64202 3 057102																																																																																																																																				
6,2 x 10,7	64202 3 062107																																																																																																																																				
5,7 x 14,2	64202 3 057142																																																																																																																																				
6,2 x 14,7	64202 3 062147																																																																																																																																				
6,7 x 12,2	64202 3 067122																																																																																																																																				
7,2 x 12,7	64202 3 072127																																																																																																																																				
7,7 x 14,2	64202 3 077142																																																																																																																																				
8,2 x 14,7	64202 3 082147																																																																																																																																				
9,2 x 14,2	64202 3 092142																																																																																																																																				
9,7 x 14,7	64202 3 097147																																																																																																																																				
10,2 x 14,2	64202 3 102142																																																																																																																																				
10,7 x 14,7	64202 3 107147																																																																																																																																				
<div style="background-color: #800000; color: white; padding: 2px; margin-bottom: 5px;">No 4</div> 																																																																																																																																					
N° referencia																																																																																																																																					
<table style="width: 100%; border-collapse: collapse;"> <tr><td style="padding: 2px;">11,0</td><td style="padding: 2px;">64004 2110</td></tr> <tr><td style="padding: 2px;">12,0</td><td style="padding: 2px;">64004 2120</td></tr> <tr><td style="padding: 2px;">13,0</td><td style="padding: 2px;">64004 2130</td></tr> <tr><td style="padding: 2px;">14,0</td><td style="padding: 2px;">64004 2140</td></tr> <tr><td style="padding: 2px;">15,0</td><td style="padding: 2px;">64004 2150</td></tr> <tr><td style="padding: 2px;">16,0</td><td style="padding: 2px;">64004 2160</td></tr> <tr><td style="padding: 2px;">17,0</td><td style="padding: 2px;">64004 2170</td></tr> <tr><td style="padding: 2px;">18,0</td><td style="padding: 2px;">64004 2180</td></tr> <tr><td style="padding: 2px;">19,0</td><td style="padding: 2px;">64004 2190</td></tr> <tr><td style="padding: 2px;">20,0*</td><td style="padding: 2px;">64004 2200</td></tr> <tr><td style="padding: 2px;">21,0*</td><td style="padding: 2px;">64004 2210</td></tr> </table>	11,0	64004 2110	12,0	64004 2120	13,0	64004 2130	14,0	64004 2140	15,0	64004 2150	16,0	64004 2160	17,0	64004 2170	18,0	64004 2180	19,0	64004 2190	20,0*	64004 2200	21,0*	64004 2210																																																																																																															
11,0	64004 2110																																																																																																																																				
12,0	64004 2120																																																																																																																																				
13,0	64004 2130																																																																																																																																				
14,0	64004 2140																																																																																																																																				
15,0	64004 2150																																																																																																																																				
16,0	64004 2160																																																																																																																																				
17,0	64004 2170																																																																																																																																				
18,0	64004 2180																																																																																																																																				
19,0	64004 2190																																																																																																																																				
20,0*	64004 2200																																																																																																																																				
21,0*	64004 2210																																																																																																																																				
*gran tamaño																																																																																																																																					
		<table style="width: 100%; border-collapse: collapse;"> <tr> <th style="padding: 2px;">holgura</th> <th style="padding: 2px;">grosor del material</th> </tr> <tr> <td style="padding: 2px;">0,2 mm</td> <td style="padding: 2px;">hasta 4 mm</td> </tr> <tr> <td style="padding: 2px;">0,7 mm</td> <td style="padding: 2px;">4 – 9 mm</td> </tr> </table>	holgura	grosor del material	0,2 mm	hasta 4 mm	0,7 mm	4 – 9 mm																																																																																																																													
holgura	grosor del material																																																																																																																																				
0,2 mm	hasta 4 mm																																																																																																																																				
0,7 mm	4 – 9 mm																																																																																																																																				





Peddinghaus

Peddinghaus Anlagen & Maschinen GmbH

Peddinghaus Española, S.A.
 Pol. Ind. Gojain
 01170 Legutiano - Alava - España
 tel. +34 945 46 53 70
 fax +34 945 46 55 26
 pesa@peddinghaus.es • www.peddy.de

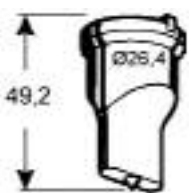
Serie Roja

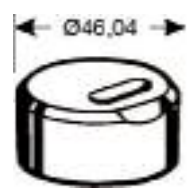
punzón ovalado		matriz ovalada		matriz ovalada descentrada, longitudinal		matriz ovalada descentrada, transversal	
No 4		No 2		No 13		No 13	
							
—	N° referencia	—	N° referencia	—	N° referencia	—	N° referencia
				6,2x14,7	64213 3 062147	6,2x14,7	64213 4 062147
				9,7x14,7	64213 3 097147	9,7x14,7	64213 4 097147
5,5x19	64004 3055190	5,7x19,2	64202 3 057192				
		6,2x19,7	64202 3 062197				
5,5x25	64004 3055250	5,7x25,2	64202 3 057252				
		6,2x25,7	64202 3 062257	6,2x25,7	64213 3 062257	6,2x25,7	64213 4 062257
6,5x18	64004 3065180	6,7x18,2	64202 3 067182				
		7,2x18,7	64202 3 072187				
6,5x26	64004 3065260	6,7x26,2	64202 3 067262				
		7,2x26,7	64202 3 072267	7,2x26,7	64213 3 072267	7,2x26,7	64213 4 072267
7,5x21	64004 3075210	7,7x21,2	64202 3 077212				
		8,2x21,7	64202 3 082217				
7,5x26	64004 3075260	7,7x26,2	64202 3 077262				
		8,2x26,7	64202 3 082267	8,2x26,7	64213 3 082267	8,2x26,7	64213 4 082267
9,0x18	64004 3090180	9,2x18,2	64202 3 092182				
		9,7x18,7	64202 3 097187				
9,0x26	64004 3090260	9,2x26,2	64202 3 092262	9,7x26,7	64213 3 097267	9,7x26,7	64213 4 097267
		9,7x26,7	64202 3 097267				
10,0x20	64004 3100200	10,2x20,2	64202 3 102202	10,7x20,7	64213 3 107207	10,7x20,7	64213 4 107207
		10,7x20,7	64202 3 107207				
10,0x26	64004 3100260	10,2x26,2	64202 3 102262				
		10,7x26,7	64202 3 107267				
11,0x22	64004 3110220	11,2x22,2	64202 3 112222	11,7x22,7	64213 3 117227	11,7x22,7	64213 4 117227
		11,7x22,7	64202 3 117227				
11,0x26	64004 3110260	11,2x26,2	64202 3 112262	11,7x26,7	64213 3 117267	11,7x26,7	64213 4 117267
		11,7x26,7	64202 3 117267				
12,0x24	64004 3120240	12,2x24,2	64202 3 122242				
		12,7x24,7	64202 3 127247				
13,0x26	64004 3130260	13,2x26,2	64202 3 132262	13,7x26,7	64213 3 137267	13,7x26,7	64213 4 137267
		13,7x26,7	64202 3 137267				
14,0x26	64004 3140260	14,2x26,2	64202 3 142262	14,7x26,7	64213 3 147267	14,7x26,7	64213 4 147267
		14,7x26,7	64202 3 147267				
16,0x26	64004 3160260	16,2x26,2	64202 3 162262	16,7x26,7	64213 3 167267	16,7x26,7	64213 4 167267
		16,7x26,7	64202 3 167267				
18,0x26	64004 3180260	18,2x26,2	64202 3 182262				
		18,7x26,7	64202 3 187267				

holgura: **0,2 mm** (grosor del material: hasta 4 mm) • **0,7 mm** (grosor del material: 4 – 9 mm)

Serie Roja

punzón rectangular		matriz rectangular		punzón de esquina redondeada		matriz de esquina redondeada	
No 4		No 2		No 4		No 2	
	N° referencia		N° referencia		N° referencia		N° referencia
5,0x15	64004 5 050150	5,2x15,2	64202 5 052152	radio		radio	
		5,7x15,7	64202 5 057157	5	65004 37 00050	5	65202 37 00050
5,0x20	64004 5 050200	5,2x20,2	64202 5 052202	10	65004 37 00100	10	65202 37 00100
		5,7x20,7	64202 5 057207	14	65004 37 00140	14	65202 37 00140
6,0x24	64004 5 060240	6,2x24,2	64202 5 062242	<p>punzón cuadrado c/bordes redondeados</p> <p>No 4</p> <p>N° referencia</p> <p>Ø 22,2 x 20,3 65004 38 222203</p>			
8,0x16	64004 5 080160	8,2x16,2	64202 5 082162				
		8,7x16,7	64202 5 087167				
8,0x24	64004 5 080240	8,2x24,2	64202 5 082242				
		8,7x24,7	64202 5 087247				
9,0x24	64004 5 090240	9,2x24,2	64202 5 092242				
		9,7x24,7	64202 5 097247				
10,0x20	64004 5 100200	10,2x20,2	64202 5 102202				
		10,7x20,7	64202 5 107207				
11,0x22	64004 5 110220	11,2x22,2	64202 5 112222				
		11,7x22,7	64202 5 117227				
12,0x22	64004 5 120220	12,2x22,2	64202 5 122222				
		12,7x22,7	64202 5 127227				
14,0x20	64004 5 140200	14,2x20,2	64202 5 142202				
		14,7x20,7	64202 5 147207				
16,0x20	64004 5 160200	16,2x20,2	64202 5 162202				
		16,7x20,7	64202 5 167207				
		<p>matriz cuadrada c/bordes redondeados</p> <p>No 2</p> <p>N° referencia</p> <p>Ø 22,4 x 20,5 65202 38 224205</p>					
		<p>holgura:</p> <p>0,2 mm (grosor del material: hasta 4 mm)</p> <p>0,7 mm (grosor del material: 4 – 9 mm)</p>					



Serie Roja

Punzones especiales para punzonado de acero inoxidable

punzón redondo especial

Nr. 1

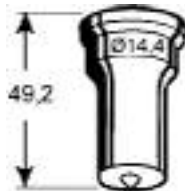

N° referencia

3,0	P-65001 8004 030
4,0	P-65001 8004 040
4,5	P-65001 8004 045
5,0	P-65001 8004 050
6,0	P-65001 8004 060
7,0	P-65001 8004 070
8,0	P-65001 8004 080
9,0	P-65001 8004 090
10,0	P-65001 8004 100
11,0	P-65001 8004 110
12,0	P-65001 8004 120
13,0	P-65001 8004 130
14,0	P-65001 8004 140

matriz redonda (estándar)

Nr. 2

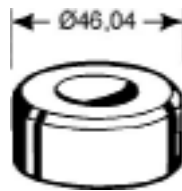

N° referencia

3,2	64202 1032
3,7	64202 1037
4,2	64202 1042
4,7	64202 1047
5,2	64202 1052
5,7	64202 1057
6,2	64202 1062
6,7	64202 1067
7,2	64202 1072
7,7	64202 1077
8,2	64202 1072
8,7	64202 1077
9,2	64202 1092
9,7	64202 1097
10,2	64202 1102
10,7	64202 1107
11,2	64202 1112
11,7	64202 1117
12,2	64202 1122
12,7	64202 1127
13,2	64202 1132
13,7	64202 1137
14,2	64202 1142
14,7	64202 1147
15,2	64202 1152

punzón redondo especial

Nr. 4

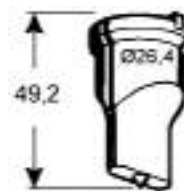

N° referencia

9,0 x 26,0	P-65004 8008 01
11,0 x 26,0	P-65004 8008 02
13,0 x 26,0	P-65004 8008 03

matriz redonda (estándar)

Nr. 2



N° referencia

9,7 x 26,7	64202 3 097267
11,7 x 26,7	64202 3 117267
12,2 x 27,2	64202 3 122272
13,7 x 26,7	64202 3 137267
14,2 x 27,2	64202 3 142272