



Punzones y matrices

Peddy Peddicat 275 H

**21/16
36 RP/10**





Peddinghaus Anlagen & Maschinen GmbH

Peddinghaus Española, S.A.
 Pol. Ind. Gojain
 01170 Legutiano - Alava - España
 tel. +34 945 46 53 70
 fax +34 945 46 55 26
 pesa@peddinghaus.es • www.peddy.de

Peddy • Peddicat 275 H • 21/16 • 36 RP 10

punzón redondo

No 55

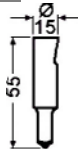

Nº referencia

- 3,0 62055 1030
- 3,5 62055 1035
- 4,0 62055 1040
- 4,5 62055 1045
- 5,0 62055 1050
- 5,5 62055 1055
- 6,0 62055 1060
- 6,5 62055 1065
- 7,0 62055 1070
- 7,5 62055 1075
- 8,0 62055 1080
- 8,5 62055 1085
- 9,0 62055 1090
- 9,5 62055 1095
- 10,0 62055 1100
- 10,5 62055 1105
- 11,0 62055 1110
- 11,5 62055 1115
- 12,0 62055 1120
- 12,5 62055 1125
- 13,0 62055 1130
- 13,5 62055 1135
- 14,0 62055 1140
- 14,5 62055 1145
- 15,0 62055 1150

punzón redondo

No 56

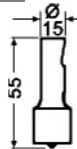

Nº referencia

- 15,5 62056 1155
- 16,0 62056 1160
- 16,5 62056 1165
- 17,0 62056 1170
- 17,5 62056 1175
- 18,0 62056 1180
- 18,5 62056 1185
- 19,0 62056 1190
- 19,5 62056 1195
- 20,0 62056 1200
- 20,5 62056 1205
- 21,0 62056 1210
- 21,5 62056 1215
- 22,0 62056 1220

punzón redondo

No 57*

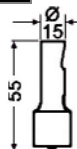

Nº referencia

- 23,0 62057 1230
- 24,0 62057 1240
- 25,0 62057 1250
- 30,0 62057 1300

matriz redonda

No 57



Nº referencia

- 3,2 62257 1032
- 3,7 62257 1037
- 4,2 62257 1042
- 4,7 62257 1047
- 5,2 62257 1052
- 5,7 62257 1057
- 6,2 62257 1062
- 6,7 62257 1067
- 7,2 62257 1072
- 7,7 62257 1077
- 8,2 62257 1082
- 8,7 62257 1087
- 9,2 62257 1092
- 9,7 62257 1097
- 10,2 62257 1102
- 10,7 62257 1107
- 11,2 62257 1112
- 11,7 62257 1117
- 12,2 62257 1122
- 12,7 62257 1127
- 13,2 62257 1132
- 13,7 62257 1137
- 14,2 62257 1142
- 14,7 62257 1147
- 15,2 62257 1152
- 15,7 62257 1157
- 16,2 62257 1162
- 16,7 62257 1167
- 17,2 62257 1172
- 17,7 62257 1177
- 18,2 62257 1182
- 18,7 62257 1187
- 19,2 62257 1192
- 19,7 62257 1197
- 20,2 62257 1202
- 20,7 62257 1207
- 21,2 62257 1212
- 21,7 62257 1217
- 22,2 62257 1222
- 22,7 62257 1227

matriz redonda

No 3*



Nº referencia

- 3,2 64203 1032
- 3,7 64203 1037
- 4,2 64203 1042
- 4,7 64203 1047
- 5,2 64203 1052
- 5,7 64203 1057
- 6,2 64203 1062
- 6,7 64203 1067
- 7,2 64203 1072
- 7,7 64203 1077
- 8,2 64203 1082
- 8,7 64203 1087
- 9,2 64203 1092
- 9,7 64203 1097
- 10,2 64203 1102
- 10,7 64203 1107
- 11,2 64203 1112
- 11,7 64203 1117
- 12,2 64203 1122
- 12,7 64203 1127
- 13,2 64203 1132
- 13,7 64203 1137
- 14,2 64203 1142
- 14,7 64203 1147
- 15,2 64203 1152
- 15,7 64203 1157

*sólo para Peddy + Peddicat 275 H

matriz redonda

No 3*

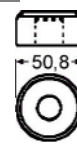

Nº referencia

- 16,2 64203 1162
- 16,7 64203 1167
- 17,2 64203 1172
- 17,7 64203 1177
- 18,2 64203 1182
- 18,7 64203 1187
- 19,2 64203 1192
- 19,7 64203 1197
- 20,2 64203 1202
- 20,7 64203 1207
- 21,2 64203 1212
- 21,7 64203 1217
- 22,2 64203 1222
- 22,7 64203 1227
- 23,2 64203 1232
- 23,7 64203 1237
- 24,2 64203 1242
- 24,7 64203 1247
- 25,2 64203 1252
- 25,7 64203 1257
- 26,2 64203 1262
- 26,7 64203 1267
- 27,2 64203 1272
- 27,7 64203 1277
- 28,2 64203 1282
- 28,7 64203 1287
- 29,2 64203 1292
- 29,7 64203 1297
- 30,2 64203 1302
- 30,7 64203 1307

Peddy • Peddicat 275 H • 21/16 • 36 RP 10

punzón cuadrado

No 55

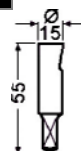

N° referencia

4,0	62055 2040
5,0	62055 2050
6,0	62055 2060
7,0	62055 2070
8,0	62055 2080
9,0	62055 2090
10,0	62055 2100

punzón cuadrado

No 56

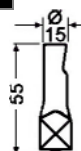

N° referencia

11,0	62056 2110
12,0	62056 2120
13,0	62056 2130
14,0	62056 2140
15,0	62056 2150

matriz cuadrada

No 57



N° referencia

4,2	62257 2042
4,7	62257 2047
5,2	62257 2052
5,7	62257 2057
6,2	62257 2062
6,7	62257 2067
7,2	62257 2072
7,7	62257 2077
8,2	62257 2082
8,7	62257 2087
9,2	62257 2092
9,7	62257 2097
10,2	62257 2102
10,7	62257 2107
11,2	62257 2112
11,7	62257 2117
12,2	62257 2122
12,7	62257 2127
13,2	62257 2132
13,7	62257 2137
14,2	62257 2142
14,7	62257 2147
15,2	62257 2152
15,7	62257 2157

matriz cuadrada

No 3*

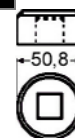

N° referencia

4,2	64203 2042
4,7	64203 2047
5,2	64203 2052
5,7	64203 2057
6,2	64203 2062
6,7	64203 2067
7,2	64203 2072
7,7	64203 2077
8,2	64203 2082
8,7	64203 2087
9,2	64203 2092
9,7	64203 2097
10,2	64203 2102
10,7	64203 2107
11,2	64203 2112
11,7	64203 2117
12,2	64203 2122
12,7	64203 2127
13,2	64203 2132
13,7	64203 2137
14,2	64203 2142
14,7	64203 2147
15,2	64203 2152
15,7	64203 2157

* sólo para
Peddy + Peddicat 275 H

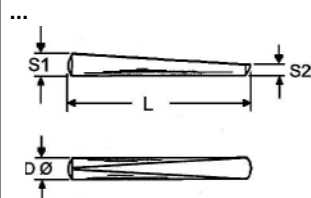

D Ø	S1	S2	L	N° referencia
5	4,4	3,2	40	40610 5 4081 02 M



Peddinghaus Anlagen & Maschinen GmbH

Peddinghaus Española, S.A.
 Pol. Ind. Gojain
 01170 Legutiano - Alava - España
 tel. +34 945 46 53 70
 fax +34 945 46 55 26
 pesa@peddinghaus.es • www.peddy.de

Peddy • Peddicat 275 H • 21/16 • 36 RP 10

punzón ovalado

No 55

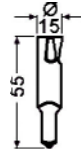

	N° referencia
5,0 x 10	62055 3050100
5,5 x 14	62055 3055140
6,5 x 12	62055 3065120
7,5 x 14	62055 3075140

punzón ovalado

No 56

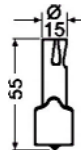

	N° referencia
6,5 x 18	62056 3065180
7,5 x 21	65056 3075210
9,0 x 18	62056 3090180
10,0 x 20	62056 3100200
11,0 x 22	62056 3110220
12,0 x 20	62056 3120200

matriz ovalada

No 57*

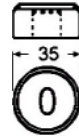

	N° referencia
5,2x10,2	62257 3052102
5,7x10,7	62257 3057107
5,7x14,2	62257 3057142
6,2x14,7	62257 3062147
6,7x12,2	62257 3067122
7,2x12,7	62257 3072127
7,7x14,2	62257 3077142
8,2x14,7	62257 3082147

matriz ovalada

No 3*

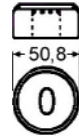

	N° referencia
5,2x10,2	64203 3052102
5,7x10,7	64203 3057107
5,7x14,2	64203 3057142
6,2x14,7	64203 3062147
6,7x12,2	64203 3067122
7,2x12,7	64203 3072127
7,7x14,2	64203 3077142
8,2x14,7	64203 3082147

chaveta

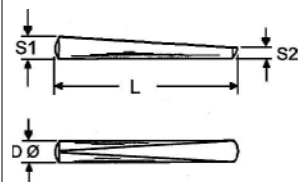

D Ø	S1	S2	L	N° referencia
5	4,4	3,2	40	40610 5 4081 02 M

* sólo para **Peddy + Peddicat 275 H**



Peddinghaus Anlagen & Maschinen GmbH

Peddy • Peddicat 275 H

punzón ovalado

No 57

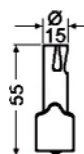

matriz ovalada

No 3

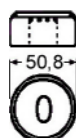

punzón para cerradura, transversal

No 57

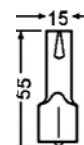

Nº referencia		Nº referencia		Nº referencia	
6,5 x 26	62057 3065260	6,7x26,2	64203 3067262	34 x Ø 17,5 x 10,5	62057 17 001
7,5 x 26	62057 3075260	7,2x26,7	64203 3072267		
9,0 x 26	62057 3090260	7,7x26,2	64203 3077262		
9,0 x 30	62057 3090300	8,2x26,7	64203 3082267		
10,0 x 26	62057 3100260	9,2x26,2	64203 3092262		
10,0 x 30	62057 3090300	9,7x26,7	64203 3097267		
10,0 x 26	62057 3100260	9,2x30,2	64203 3092302		
10,0 x 30	62057 3100300	9,7x30,7	64203 3097307		
11,0 x 26	62057 3110260	10,2x26,2	64203 3102262		
11,0 x 30	62057 3110300	10,7x26,7	64203 3107267		
11,0 x 26	62057 3110260	10,2x30,2	64203 3102302		
11,0 x 30	62057 3110300	10,7x30,7	64203 3107307		
12,0 x 24	62057 3120240	11,2x26,2	64203 3112262		
12,0 x 30	62057 3120300	11,7x26,7	64203 3117267		
13,0 x 26	62057 3130260	11,2x30,2	64203 3112302		
13,0 x 30	62057 3130300	11,7x30,7	64203 3117307		
14,0 x 28	62057 3140280	12,2x24,2	64203 3122242		
		12,7x24,7	64203 3127247		
		12,2x30,2	64203 3122302		
		12,7x30,7	64203 3127307		
		13,2x26,2	64203 3132262		
		13,7x26,7	64203 3137267		
		13,2x30,2	64203 3132302		
		13,7x30,7	64203 3137307		
		14,2x28,2	64203 3142282		
		14,7x28,7	64203 3147287		
				matriz para cerradura	
		No 3			
				Nº referencia	
				34,2 x Ø 17,7 x 10,7	65203 17 001

Peddy

desde nr. PA 2000

Dispositivo de punzonado estándar

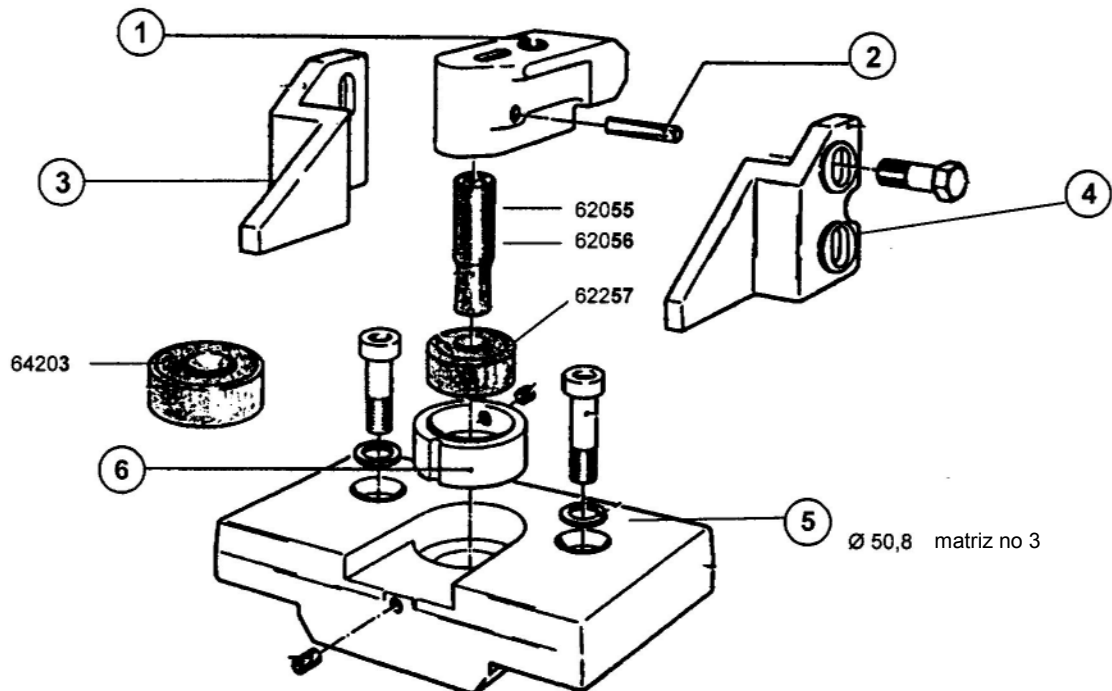

Nr.	Description	N° referencia
1	portapunzón	40610 199 953 C
2	chaveta	40610 5 4081 02 M
3	separador, izdo	40610 5 4081 06
4	separador, dcho	40610 5 4081 05
5	portamatriz	40610 199 954 E
1-5 dispositivo de punzonado estándar, completo		40610 5 4081 00 A
6	reductor para matriz	40610 199 957