

Stempel und Matrizen • Punches and Dies • Poinçons et matrices

**Peddy
Peddicat 275 H**

**21/16
36 RP/10**

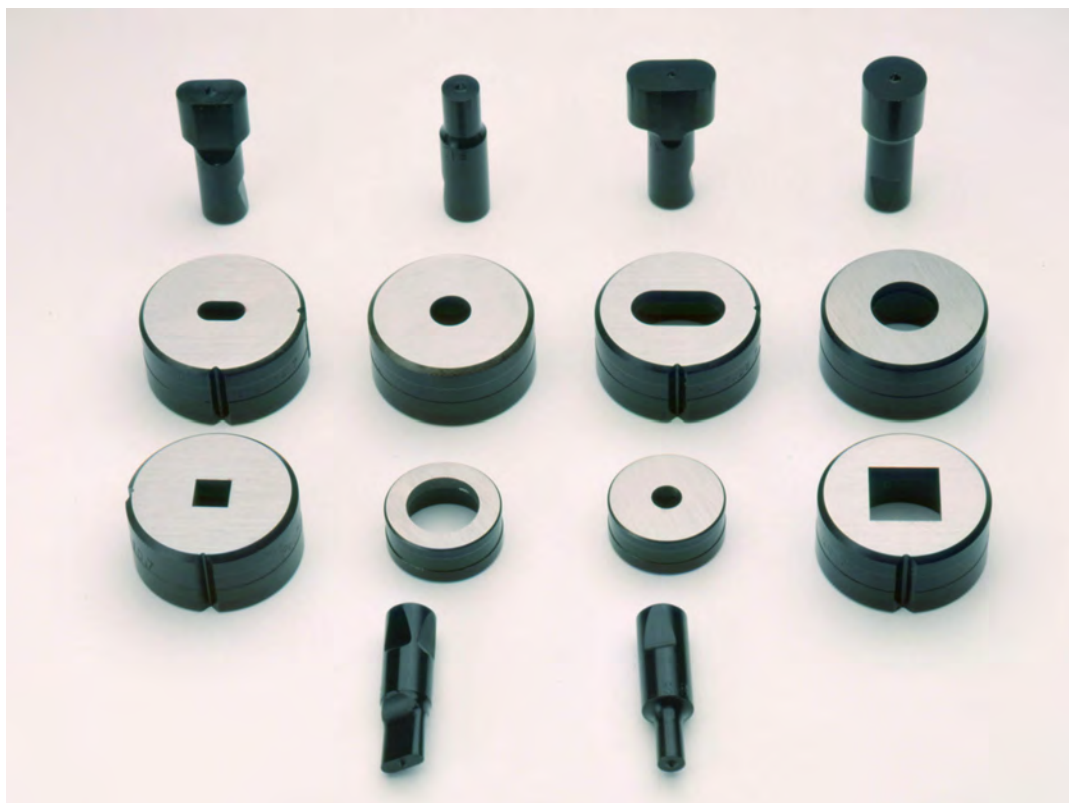



Peddinghaus

Peddinghaus Anlagen & Maschinen GmbH

Peddinghaus Anlagen & Maschinen GmbH
 Hasslinghauser Str. 156 • D-58285 Gevelsberg
 Tel. +49 (0) 2332 / 6646-20/21/22/23/24
 Fax +49 (0) 2332 / 6646-46
 teile-pam@peddy.de • www.peddy.de

Peddy • Peddicat 275 H • 21/16 • 36 RP 10

Rundstempel
 round punch
 poinçon rond

Nr. 55



Artikel-Nr.

- 3,0 62055 1030
- 3,5 62055 1035
- 4,0 62055 1040
- 4,5 62055 1045
- 5,0 62055 1050
- 5,5 62055 1055
- 6,0 62055 1060
- 6,5 62055 1065
- 7,0 62055 1070
- 7,5 62055 1075
- 8,0 62055 1080
- 8,5 62055 1085
- 9,0 62055 1090
- 9,5 62055 1095
- 10,0 62055 1100
- 10,5 62055 1105
- 11,0 62055 1110
- 11,5 62055 1115
- 12,0 62055 1120
- 12,5 62055 1125
- 13,0 62055 1130
- 13,5 62055 1135
- 14,0 62055 1140
- 14,5 62055 1145
- 15,0 62055 1150

Rundstempel
 round punch
 poinçon rond

Nr. 56



Artikel-Nr.

- 15,5 62056 1155
- 16,0 62056 1160
- 16,5 62056 1165
- 17,0 62056 1170
- 17,5 62056 1175
- 18,0 62056 1180
- 18,5 62056 1185
- 19,0 62056 1190
- 19,5 62056 1195
- 20,0 62056 1200
- 20,5 62056 1205
- 21,0 62056 1210
- 21,5 62056 1215
- 22,0 62056 1220

Rundstempel
 round punch
 poinçon rond

Nr. 57*

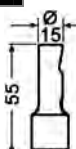

Artikel-Nr.

- 23,0 62057 1230
- 24,0 62057 1240
- 25,0 62057 1250
- 30,0 62057 1300

Rundmatrize
 round die
 matrice ronde

Nr. 57

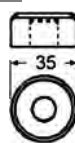

Artikel-Nr.

- 3,2 62257 1032
- 3,7 62257 1037
- 4,2 62257 1042
- 4,7 62257 1047
- 5,2 62257 1052
- 5,7 62257 1057
- 6,2 62257 1062
- 6,7 62257 1067
- 7,2 62257 1072
- 7,7 62257 1077
- 8,2 62257 1082
- 8,7 62257 1087
- 9,2 62257 1092
- 9,7 62257 1097
- 10,2 62257 1102
- 10,7 62257 1107
- 11,2 62257 1112
- 11,7 62257 1117
- 12,2 62257 1122
- 12,7 62257 1127
- 13,2 62257 1132
- 13,7 62257 1137
- 14,2 62257 1142
- 14,7 62257 1147
- 15,2 62257 1152
- 15,7 62257 1157
- 16,2 62257 1162
- 16,7 62257 1167
- 17,2 62257 1172
- 17,7 62257 1177
- 18,2 62257 1182
- 18,7 62257 1187
- 19,2 62257 1192
- 19,7 62257 1197
- 20,2 62257 1202
- 20,7 62257 1207
- 21,2 62257 1212
- 21,7 62257 1217
- 22,2 62257 1222
- 22,7 62257 1227

Rundmatrize
 round die
 matrice ronde

Nr. 3*



Artikel-Nr.

- 3,2 64203 1032
- 3,7 64203 1037
- 4,2 64203 1042
- 4,7 64203 1047
- 5,2 64203 1052
- 5,7 64203 1057
- 6,2 64203 1062
- 6,7 64203 1067
- 7,2 64203 1072
- 7,7 64203 1077
- 8,2 64203 1082
- 8,7 64203 1087
- 9,2 64203 1092
- 9,7 64203 1097
- 10,2 64203 1102
- 10,7 64203 1107
- 11,2 64203 1112
- 11,7 64203 1117
- 12,2 64203 1122
- 12,7 64203 1127
- 13,2 64203 1132
- 13,7 64203 1137
- 14,2 64203 1142
- 14,7 64203 1147
- 15,2 64203 1152
- 15,7 64203 1157

*nur für
 *only for
 *uniquement pour

Rundmatrize
 round die
 matrice ronde

Nr. 3*



Artikel-Nr.

- 16,2 64203 1162
- 16,7 64203 1167
- 17,2 64203 1172
- 17,7 64203 1177
- 18,2 64203 1182
- 18,7 64203 1187
- 19,2 64203 1192
- 19,7 64203 1197
- 20,2 64203 1202
- 20,7 64203 1207
- 21,2 64203 1212
- 21,7 64203 1217
- 22,2 64203 1222
- 22,7 64203 1227
- 23,2 64203 1232
- 23,7 64203 1237
- 24,2 64203 1242
- 24,7 64203 1247
- 25,2 64203 1252
- 25,7 64203 1257
- 26,2 64203 1262
- 26,7 64203 1267
- 27,2 64203 1272
- 27,7 64203 1277
- 28,2 64203 1282
- 28,7 64203 1287
- 29,2 64203 1292
- 29,7 64203 1297
- 30,2 64203 1302
- 30,7 64203 1307

Peddy + Peddicat 275 H

Peddy • Peddicat 275 H • 21/16 • 36 RP 10

Vierkantstempel
square punch
poinçon carré

Nr. 55

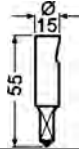

Artikel-Nr.

4,0	62055 2040
5,0	62055 2050
6,0	62055 2060
7,0	62055 2070
8,0	62055 2080
9,0	62055 2090
10,0	62055 2100

Vierkantstempel
square punch
poinçon carré

Nr. 56

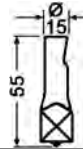

Artikel-Nr.

11,0	62056 2110
12,0	62056 2120
13,0	62056 2130
14,0	62056 2140
15,0	62056 2150

Vierkantmatrize
square die
matrice carrée

Nr. 57



Artikel-Nr.

4,2	62257 2042
4,7	62257 2047
5,2	62257 2052
5,7	62257 2057
6,2	62257 2062
6,7	62257 2067
7,2	62257 2072
7,7	62257 2077
8,2	62257 2082
8,7	62257 2087
9,2	62257 2092
9,7	62257 2097
10,2	62257 2102
10,7	62257 2107
11,2	62257 2112
11,7	62257 2117
12,2	62257 2122
12,7	62257 2127
13,2	62257 2132
13,7	62257 2137
14,2	62257 2142
14,7	62257 2147
15,2	62257 2152
15,7	62257 2157

Vierkantmatrize
square die
matrice carrée

Nr. 3*



Artikel-Nr.

4,2	64203 2042
4,7	64203 2047
5,2	64203 2052
5,7	64203 2057
6,2	64203 2062
6,7	64203 2067
7,2	64203 2072
7,7	64203 2077
8,2	64203 2082
8,7	64203 2087
9,2	64203 2092
9,7	64203 2097
10,2	64203 2102
10,7	64203 2107
11,2	64203 2112
11,7	64203 2117
12,2	64203 2122
12,7	64203 2127
13,2	64203 2132
13,7	64203 2137
14,2	64203 2142
14,7	64203 2147
15,2	64203 2152
15,7	64203 2157

Stempelkeil

taper pin
clavette de poinçon

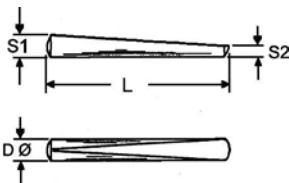

D Ø	S1	S2	L	Artikel-Nr.
5	4,4	3,2	40	40610 5 4081 02 M

*nur für
*only for
*uniquement pour

Peddy + Peddicat 275 H



Peddinghaus

Peddinghaus Anlagen & Maschinen GmbH

Peddinghaus Anlagen & Maschinen GmbH
 Hasslinghauser Str. 156 • D-58285 Gevelsberg
 Tel. +49 (0) 2332 / 6646-20/21/22/23/24
 Fax +49 (0) 2332 / 6646-46
 teile-pam@peddy.de • www.peddy.de

Peddy • Peddicat 275 H • 21/16 • 36 RP 10

Langlochstempel

oblong punch
 poinçon oblong

Nr. 55



	Artikel-Nr.
5,0 x 10	62055 3050100
5,5 x 14	62055 3055140
6,5 x 12	62055 3065120
7,5 x 14	62055 3075140

Langlochstempel

oblong punch
 poinçon oblong

Nr. 56

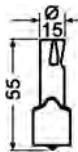

	Artikel-Nr.
6,5 x 18	62056 3065180
7,5 x 21	65056 3075210
9,0 x 18	62056 3090180
10,0 x 20	62056 3100200
11,0 x 22	62056 3110220
12,0 x 20	62056 3120200

Langlochmatrize

oblong die
 matrice oblongue

Nr. 57*



	Artikel-Nr.
5,2x10,2	62257 3052102
5,7x10,7	62257 3057107
5,7x14,2	62257 3057142
6,2x14,7	62257 3062147
6,7x12,2	62257 3067122
7,2x12,7	62257 3072127
7,7x14,2	62257 3077142
8,2x14,7	62257 3082147

Langlochmatrize

oblong die
 matrice oblongue

Nr. 3*



	Artikel-Nr.
5,2x10,2	64203 3052102
5,7x10,7	64203 3057107
5,7x14,2	64203 3057142
6,2x14,7	64203 3062147
6,7x12,2	64203 3067122
7,2x12,7	64203 3072127
7,7x14,2	64203 3077142
8,2x14,7	64203 3082147

Stempelkeil

taper pin
 clavette de poinçon

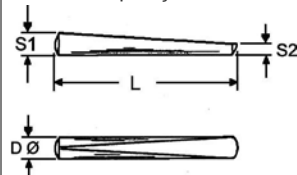

D Ø	S1	S2	L	Artikel-Nr.
5	4,4	3,2	40	40610 5 4081 02 M

*nur für **Peddy + Peddicat 275 H**

*only for
 *uniquement pour

Peddy • Peddicat 275 H

Langlochstempel
 oblong punch
 poinçon oblong

Nr. 57

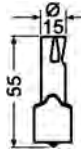

Langlochmatrize
 oblong die
 matrice oblongue

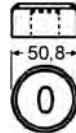

Nr. 3

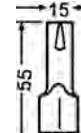

Schlüssellochstempel, quer
 keyhole punch, transverse
 poinçon pour canon européen

Nr. 57



 Artikel-Nr.	 Artikel-Nr.	 Artikel-Nr.
--	---	--

6,5 x 26	62057 3065260
7,5 x 26	62057 3075260
9,0 x 26	62057 3090260
9,0 x 30	62057 3090300
10,0 x 26	62057 3100260
10,0 x 30	62057 3100300
11,0 x 26	62057 3110260
11,0 x 30	62057 3110300
12,0 x 24	62057 3120240
12,0 x 30	62057 3120300
13,0 x 26	62057 3130260
13,0 x 30	62057 3130300
14,0 x 28	62057 3140280

6,7x26,2	64203 3067262
7,2x26,7	64203 3072267
7,7x26,2	64203 3077262
8,2x26,7	64203 3082267
9,2x26,2	64203 3092262
9,7x26,7	64203 3097267
9,2x30,2	64203 3092302
9,7x30,7	64203 3097307
10,2x26,2	64203 3102262
10,7x26,7	64203 3107267
10,2x30,2	64203 3102302
10,7x30,7	64203 3107307
11,2x26,2	64203 3112262
11,7x26,7	64203 3117267
11,2x30,2	64203 3112302
11,7x30,7	64203 3117307
12,2x24,2	64203 3122242
12,7x24,7	64203 3127247
12,2x30,2	64203 3122302
12,7x30,7	64203 3127307
13,2x26,2	64203 3132262
13,7x26,7	64203 3137267
13,2x30,2	64203 3132302
13,7x30,7	64203 3137307
14,2x28,2	64203 3142282
14,7x28,7	64203 3147287

34 x Ø 17,5 x 10,5 62057 17 001

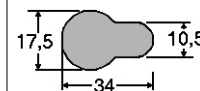

Schlüssellochmatrize
 keyhole die
 matrice pour canon européen

Nr. 3

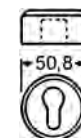

 Artikel-Nr.

34,2 x Ø 17,7 x 10,7 65203 17 001

Peddy

ab Maschinen-Nr. PA 2000

Normal-Stanzwerkzeug Standard Punching Attachment Dispositif de poinçonnage standard

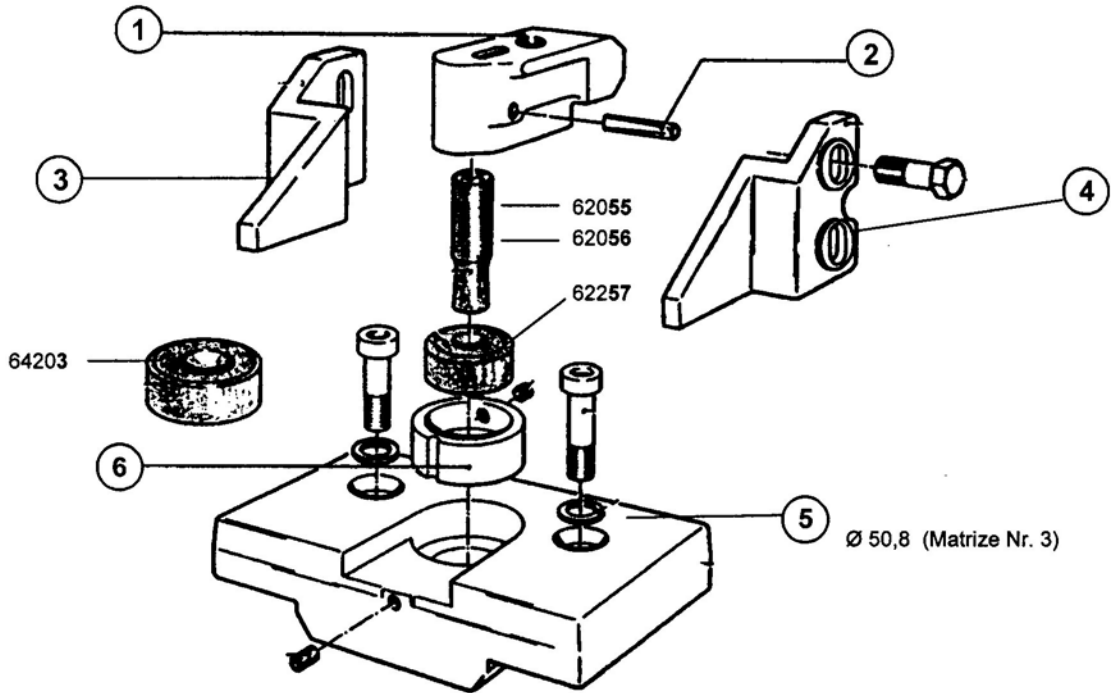

Pos.	Bezeichnung	Description	Description	Artikel-Nr.
1	Stempelhalter, komplett	punch holder	porte-poinçon	40610 199 953 C
2	Stempelkeil	taper pin	clavette de poinçon	40610 5 4081 02 M
3	Abstreifer, links	stripper, l.h.	dévêtisseur, à gauche	40610 5 4081 06
4	Abstreifer, rechts	stripper, r.h.	dévêtisseur, à droite	40610 5 4081 05
5	Matrizenhalter, komplett	die holder, complete	porte-matrice complet	40610 199 954 E
1-5	Normal-Stanzwerkzeug, komplett	standard punching attachment, complete	dispositif de poinçonnage complet	40610 5 4081 00 A
	nur für Ersatz:	not included in the scope of delivery:	non compris dans la livraison:	
6	Reduziereinsatz	reducing socket	bague de réduction	40610 199 957