



# Peddinghaus

Peddinghaus Anlagen & Maschinen GmbH

Peddinghaus Anlagen & Maschinen GmbH  
Hasslinghauser Str. 156 • D-58285 Gevelsberg  
Tel. +49 (0) 2332 / 6646-20/21/22/23/24  
Fax +49 (0) 2332 / 6646-46  
teile-pam@peddy.de • www.peddy.de

## Grüne Serie • Green Series • Série verte

für Modelle der heutigen Generation:  
for machines of the current generation:  
pour machines de la génération actuelle:

Peddicat No. 1

Peddiworker No. 1

Hydraulic 280 • 502 • 1001

für ältere Modelle:  
for older machine types:  
pour modèles plus anciens:

Peddicat 361 • 380 • 500

Peddiworker 501 • 502 • 801 • 802 • 1000 G

Peddimaster 100/160 • 110/170 • 800/1100 • 1100/1700

Peddimax 600 • 601 • 800 • 801 • 110/140 • 1002

Hydraulic 100 • 301 • 501 • 800 • 1000

210 Super 16 • 20 • 210 Standard 16

Forax 80 • 100 • 1000

225 B/ 16 • 20 • 80 • 100

225 H/ 15 • 20

### Stempel und Matrizen zur Schnellspann-Vorrichtung

Punches and dies for the quick-change punching attachment

Poinçons et matrices pour utilisation dans le dispositif de serrage rapide

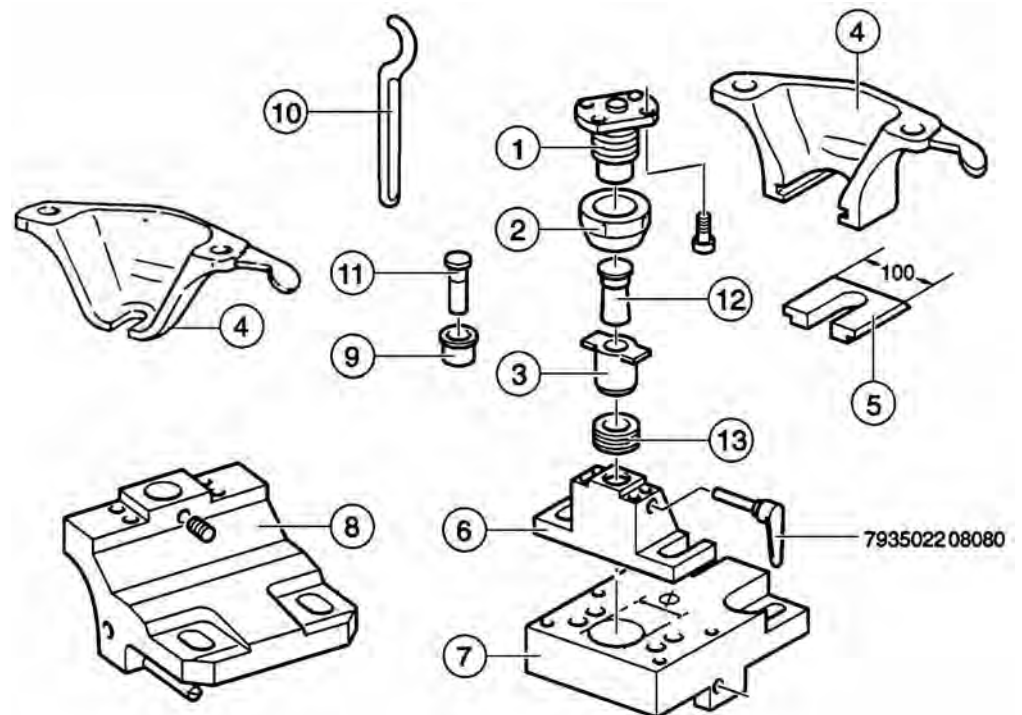

Grüne Serie • Green Series • Série verte

**Rundstempel**  
 round punch  
 poinçon rond

**Nr. 2**

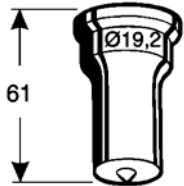

**Rundstempel**  
 round punch  
 poinçon rond

**Nr. 5**

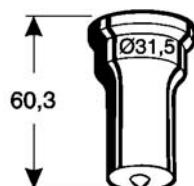

**Rundmatrize**  
 round die  
 matrice ronde

**Nr. 3**

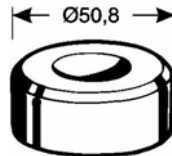

**Rundmatrize**  
 round die  
 matrice ronde

**Nr. 3**

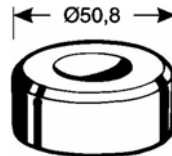

**Winkelstahlmatrize**  
 offset round die  
 matrice ronde décentrée

**Nr. 14**

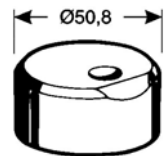

Artikel-Nr.

Artikel-Nr.

Artikel-Nr.

Artikel-Nr.

Artikel-Nr.

- 3,0 64002 1030
- 3,2 64002 1032
- 3,5 64002 1035
- 4,0 64002 1040
- 4,2 64002 1042
- 4,5 64002 1045
- 5,0 64002 1050
- 5,5 64002 1055
- 6,0 64002 1060
- 6,5 64002 1065
- 7,0 64002 1070
- 7,5 64002 1075
- 8,0 64002 1080
- 8,5 64002 1085
- 9,0 64002 1090
- 9,5 64002 1095
- 10,0 64002 1100
- 10,5 64002 1105
- 11,0 64002 1110
- 11,5 64002 1115
- 12,0 64002 1120
- 12,5 64002 1125
- 13,0 64002 1130
- 13,5 64002 1135
- 14,0 64002 1140
- 14,5 64002 1145
- 15,0 64002 1150
- 15,5 64002 1155
- 16,0 64002 1160
- 16,5 64002 1165
- 17,0 64002 1170
- 17,5 64002 1175
- 18,0 64002 1180
- 18,5 64002 1185
- 19,0 64002 1190

- 17,5 64005 1175
- 18,0 64005 1180
- 18,5 64005 1185
- 19,0 64005 1190
- 19,5 64005 1195
- 20,0 64005 1200
- 20,5 64005 1205
- 21,0 64005 1210
- 21,5 64005 1215
- 22,0 64005 1220
- 22,5 64005 1225
- 23,0 64005 1230
- 23,5 64005 1235
- 24,0 64005 1240
- 24,5 64005 1245
- 25,0 64005 1250
- 25,5 64005 1255
- 26,0 64005 1260
- 26,5 64005 1265
- 27,0 64005 1270
- 27,5 64005 1275
- 28,0 64005 1280
- 28,5 64005 1285
- 29,0 64005 1290
- 29,5 64005 1295
- 30,0 64005 1300
- 30,5 64005 1305
- 31,0 64005 1310
- 31,5 64005 1315
- 32,0 64005 1320

- 3,2 64203 1032
- 3,4 64203 1034
- 3,7 64203 1037
- 4,2 64203 1042
- 4,4 64203 1044
- 4,7 64203 1047
- 5,2 64203 1052
- 5,7 64203 1057
- 6,2 64203 1062
- 6,7 64203 1067
- 7,2 64203 1072
- 7,7 64203 1077
- 8,2 64203 1082
- 8,7 64203 1087
- 9,2 64203 1092
- 9,7 64203 1097
- 10,2 64203 1102
- 10,7 64203 1107
- 11,2 64203 1112
- 11,7 64203 1117
- 12,2 64203 1122
- 12,7 64203 1127
- 13,2 64203 1132
- 13,7 64203 1137
- 14,2 64203 1142
- 14,7 64203 1147
- 15,2 64203 1152
- 15,7 64203 1157
- 16,2 64203 1162
- 16,7 64203 1167
- 17,2 64203 1172
- 17,7 64203 1177
- 18,2 64203 1182
- 18,7 64203 1187
- 19,2 64203 1192
- 19,7 64203 1197

- 20,2 64203 1202
- 20,7 64203 1207
- 21,2 64203 1212
- 21,7 64203 1217
- 22,2 64203 1222
- 22,7 64203 1227
- 23,2 64203 1232
- 23,7 64203 1237
- 24,2 64203 1242
- 24,7 64203 1247
- 25,2 64203 1252
- 25,7 64203 1257
- 26,2 64203 1262
- 26,7 64203 1267
- 27,2 64203 1272
- 27,7 64203 1277
- 28,2 64203 1282
- 28,7 64203 1287
- 29,2 64203 1292
- 29,7 64203 1297
- 30,2 64203 1302
- 30,7 64203 1307
- 31,2 64203 1312
- 31,7 64203 1317
- 32,2 64203 1322
- 32,7 64203 1327
- 33,2 64203 1332

- 5,7 64214 1057
- 6,2 64214 1062
- 6,7 64214 1067
- 7,2 64214 1072
- 7,7 64214 1077
- 8,2 64214 1082
- 8,7 64214 1087
- 9,2 64214 1092
- 9,7 64214 1097
- 10,2 64214 1102
- 10,7 64214 1107
- 11,2 64214 1112
- 11,7 64214 1117
- 12,2 64214 1122
- 12,7 64214 1127
- 13,2 64214 1132
- 13,7 64214 1137
- 14,2 64214 1142
- 14,7 64214 1147
- 15,2 64214 1152
- 15,7 64214 1157
- 16,2 64214 1162
- 16,7 64214 1167
- 17,2 64214 1172
- 17,7 64214 1177
- 18,2 64214 1182
- 18,7 64214 1187
- 19,2 64214 1192
- 19,7 64214 1197
- 20,2 64214 1202
- 20,7 64214 1207
- 21,2 64214 1212
- 21,7 64214 1217
- 22,2 64214 1222
- 22,7 64214 1227
- 23,2 64214 1232
- 23,7 64214 1237
- 24,2 64214 1242
- 24,7 64214 1247

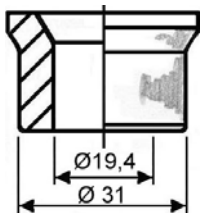

Reduzierhülse 2/5  
 reducing sleeve  
 réducteur

44081 198 503

Streichmaß: Seite 69  
 back marks: see page  
 trusquinage: voir page

Schneidspiel: Seite 67  
 clearance: see page  
 jeu: voir page



# Peddinghaus

Peddinghaus Anlagen & Maschinen GmbH

Peddinghaus Anlagen & Maschinen GmbH  
 Hasslinghauser Str. 156 • D-58285 Gevelsberg  
 Tel. +49 (0) 2332 / 6646-20/21/22/23/24  
 Fax +49 (0) 2332 / 6646-46  
 teile-pam@peddy.de • www.peddy.de

Grüne Serie • Green Series • Série verte

**Vierkantstempel**  
 square punch  
 poinçon carré

**Nr. 2**

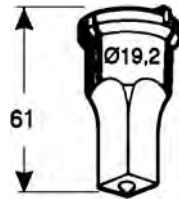

Artikel-Nr.

- 4,0 64002 2040
- 5,0 64002 2050
- 6,0 64002 2060
- 7,0 64002 2070
- 8,0 64002 2080
- 9,0 64002 2090
- 10,0 64002 2100
- 11,0 64002 2110
- 12,0 64002 2120
- 13,0 64002 2130

**Vierkantstempel**  
 square punch  
 poinçon carré

**Nr. 5**

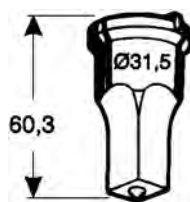

Artikel-Nr.

- 14,0 64005 2140
- 15,0 64005 2150
- 16,0 64005 2160
- 17,0 64005 2170
- 18,0 64005 2180
- 19,0 64005 2190
- 20,0 64005 2200
- 21,0 64005 2210
- 22,0 64005 2220

**Vierkantmatrize**  
 square die  
 matrice carrée

**Nr. 3**



Artikel-Nr.

- 4,2 64203 2042
- 5,2 64203 2052
- 6,2 64203 2062
- 6,7 64203 2067
- 7,2 64203 2072
- 7,7 64203 2077
- 8,2 64203 2082
- 8,7 64203 2087
- 9,2 64203 2092
- 9,7 64203 2097
- 10,2 64203 2102
- 10,7 64203 2107
- 11,2 64203 2112
- 11,7 64203 2117
- 12,2 64203 2122
- 12,7 64203 2127
- 13,2 64203 2132
- 13,7 64203 2137
- 14,2 64203 2142
- 14,7 64203 2147
- 15,2 64203 2152
- 15,7 64203 2157
- 16,2 64203 2162
- 16,7 64203 2167
- 17,2 64203 2172
- 17,7 64203 2177
- 18,2 64203 2182
- 18,7 64203 2187
- 19,2 64203 2192
- 19,7 64203 2197
- 20,2 64203 2202
- 20,7 64203 2207
- 21,2 64203 2212
- 21,7 64203 2217
- 22,2 64203 2222
- 22,7 64203 2227
- 23,2 64203 2232
- 23,7 64203 2237

**Langlochstempel**  
 oblong punch  
 poinçon oblong

**Nr. 2**

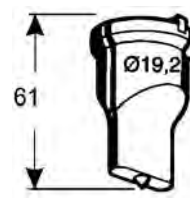

Artikel-Nr.

- 5,0 x 10,0 64002 3 050100
- 5,0 x 14,0 64002 3 050140
- 5,5 x 10,0 64002 3 055100
- 5,5 x 14,0 64002 3 055140
- 5,5 x 19,0 64002 3 055190
- 6,5 x 12,0 64002 3 065120
- 6,5 x 18,0 64002 3 065180
- 7,5 x 14,0 64002 3 075140
- 9,0 x 14,0 64002 3 090140
- 9,0 x 18,0 64002 3 090180
- 10,0 x 14,0 64002 3 100140

**Langlochmatrize**  
 oblong die  
 matrice oblongue

**Nr. 3**



Artikel-Nr.

- 5,2 x 10,2 64203 3 052102
- 5,7 x 10,7 64203 3 057107
- 5,2 x 14,2 64203 3 052142
- 5,7 x 14,7 64203 3 057147
- 5,7 x 10,2 64203 3 057102
- 6,2 x 10,7 64203 3 062107
- 5,7 x 14,2 64203 3 057142
- 6,2 x 14,7 64203 3 062147
- 5,7 x 19,2 64203 3 057192
- 6,2 x 19,7 64203 3 062197
- 6,7 x 12,2 64203 3 067122
- 7,2 x 12,7 64203 3 072127
- 6,7 x 18,2 64203 3 067182
- 7,2 x 18,7 64203 3 072187
- 7,7 x 14,2 64203 3 077142
- 8,2 x 14,7 64203 3 082147
- 9,2 x 14,2 64203 3 092142
- 9,7 x 14,7 64203 3 097147
- 9,2 x 18,2 64203 3 092182
- 9,7 x 18,7 64203 3 097187
- 10,2 x 14,2 64203 3 102142
- 10,7 x 14,7 64203 3 107147
- 11,2 x 15,2 64203 3 112152

**Schneidspiel: Materialdicke:**  
 clearance material thickness  
 jeu épaisseur mat.  
 0,2 mm bis 4 mm  
 0,7 mm 4 – 9 mm  
 1,2 mm 9 – 14 mm

siehe Seite **67**  
 see page  
 voir page

Grüne Serie • Green Series • Série verte

**Langlochstempel**  
 oblong punch  
 poinçon oblong

**Nr. 5**

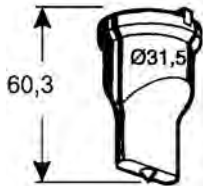

**Langlochmatrize**  
 oblong die  
 matrice oblongue

**Nr. 3**



**Langlochstempel**  
 oblong punch  
 poinçon oblong



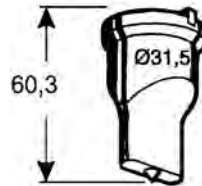

**Nr. 5**



**Langlochmatrize**  
 oblong die  
 matrice oblongue

**Nr. 3**



 Artikel-Nr.	 Artikel-Nr.	 Artikel-Nr.	 Artikel-Nr.
<b>5,5 x 25,0</b> 64005 3 055250	<b>5,7 x 25,2</b> 64203 3 057252 <b>6,2 x 25,7</b> 64203 3 062257	<b>12,0 x 24,0</b> 64005 3 120240	<b>12,2 x 24,2</b> 64203 3 122242 <b>12,7 x 24,7</b> 64203 3 127247 <b>13,2 x 25,2</b> 64203 3 132252
<b>6,5 x 26,0</b> 64005 3 065260	<b>6,7 x 26,2</b> 64203 3 067262 <b>7,2 x 26,7</b> 64203 3 072267	<b>12,0 x 30,0</b> 64005 3 120300	<b>12,2 x 30,2</b> 64203 3 122302 <b>12,7 x 30,7</b> 64203 3 127307 <b>13,2 x 31,2</b> 64203 3 132312
<b>6,5 x 30,0</b> 64005 3 065300	<b>6,7 x 30,2</b> 64203 3 067302 <b>7,2 x 30,7</b> 64203 3 072307	<b>13,0 x 26,0</b> 64005 3 130260	<b>13,2 x 26,2</b> 64203 3 132262 <b>13,7 x 26,7</b> 64203 3 137267 <b>14,2 x 27,2</b> 64203 3 142272
<b>7,5 x 21,0</b> 64005 3 075210	<b>7,7 x 21,2</b> 64203 3 077212 <b>8,2 x 21,7</b> 64203 3 082217	<b>13,0 x 30,0</b> 64005 3 130300	<b>13,2 x 30,2</b> 64203 3 132302 <b>13,7 x 30,7</b> 64203 3 137307 <b>14,2 x 31,2</b> 64203 3 142312
<b>7,5 x 26,0</b> 64005 3 075260	<b>7,7 x 26,2</b> 64203 3 077262 <b>8,2 x 26,7</b> 64203 3 082267	<b>14,0 x 26,0</b> 64005 3 140260	<b>14,2 x 26,2</b> 64203 3 142262 <b>14,7 x 26,7</b> 64203 3 147267 <b>15,2 x 27,2</b> 64203 3 152272
<b>7,5 x 30,0</b> 64005 3 075300	<b>7,7 x 30,2</b> 64203 3 077302 <b>8,2 x 30,7</b> 64203 3 082307	<b>14,0 x 28,0</b> 64005 3 140280	<b>14,2 x 28,2</b> 64203 3 142282 <b>14,7 x 28,7</b> 64203 3 147287 <b>15,2 x 29,2</b> 64203 3 152292
<b>9,0 x 26,0</b> 64005 3 090260	<b>9,2 x 26,2</b> 64203 3 092262 <b>9,7 x 26,7</b> 64203 3 097267	<b>16,0 x 26,0</b> 64005 3 160260	<b>16,2 x 26,2</b> 64203 3 162262 <b>16,7 x 26,7</b> 64203 3 167267 <b>17,2 x 27,2</b> 64203 3 172272
<b>9,0 x 30,0</b> 64005 3 090300	<b>9,2 x 30,2</b> 64203 3 092302 <b>9,7 x 30,7</b> 64203 3 097307	<b>16,0 x 31,0</b> 64005 3 160310	<b>16,2 x 31,2</b> 64203 3 162312 <b>16,7 x 31,7</b> 64203 3 167317 <b>17,2 x 32,2</b> 64203 3 172322
<b>10,0 x 20,0</b> 64005 3 100200	<b>10,2 x 20,2</b> 64203 3 102202 <b>10,7 x 20,7</b> 64203 3 107207 <b>11,2 x 21,2</b> 64203 3 112212	<b>18,0 x 26,0</b> 64005 3 180260	<b>18,2 x 26,2</b> 64203 3 182262 <b>18,7 x 26,7</b> 64203 3 187267 <b>19,2 x 27,2</b> 64203 3 192272
<b>10,0 x 26,0</b> 64005 3 100260	<b>10,2 x 26,2</b> 64203 3 102262 <b>10,7 x 26,7</b> 64203 3 107267 <b>11,2 x 27,2</b> 64203 3 112272	<b>18,0 x 31,0</b> 64005 3 180310	<b>18,2 x 31,2</b> 64203 3 182312 <b>18,7 x 31,7</b> 64203 3 187317 <b>19,2 x 32,2</b> 64203 3 192322
<b>10,0 x 30,0</b> 64005 3 100300	<b>10,2 x 30,2</b> 64203 3 102302 <b>10,7 x 30,7</b> 64203 3 107307 <b>11,2 x 31,2</b> 64203 3 112312	<b>20,0 x 31,0</b> 64005 3 200310	<b>20,2 x 31,2</b> 64203 3 202312 <b>20,7 x 31,7</b> 64203 3 207317 <b>21,2 x 32,2</b> 64203 3 212322
<b>11,0 x 22,0</b> 64005 3 110220	<b>11,2 x 22,2</b> 64203 3 112222 <b>11,7 x 22,7</b> 64203 3 117227 <b>12,2 x 23,2</b> 64203 3 122232	<b>22,0 x 31,0</b> 64005 3 220310	<b>22,2 x 31,2</b> 64203 3 222312 <b>22,7 x 31,7</b> 64203 3 227317 <b>23,2 x 32,2</b> 64203 3 232322
<b>11,0 x 26,0</b> 64005 3 110260	<b>11,2 x 26,2</b> 64203 3 112262 <b>11,7 x 26,7</b> 64203 3 117267 <b>12,2 x 27,2</b> 64203 3 122272		
<b>11,0 x 30,0</b> 64005 3 110300	<b>11,2 x 30,2</b> 64203 3 112302 <b>11,7 x 30,7</b> 64203 3 117307 <b>12,2 x 31,2</b> 64203 3 122312		

Schneidpiel / clearance / jeu: **0,2 mm** (bis 4 mm Materialdicke) • **0,7 mm** (4 – 9 mm Materialdicke) • **1,2 mm** (9 – 14 mm Materialdicke)







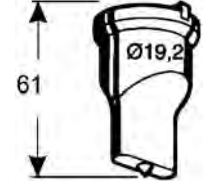
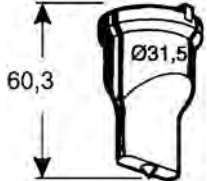

# Peddinghaus

Peddinghaus Anlagen & Maschinen GmbH

Peddinghaus Anlagen & Maschinen GmbH  
 Hasslinghauser Str. 156 • D-58285 Gevelsberg  
 Tel. +49 (0) 2332 / 6646-20/21/22/23/24  
 Fax +49 (0) 2332 / 6646-46  
 teile-pam@peddy.de • www.peddy.de

## Grüne Serie • Green Series • Série verte

<b>Langlochstempel</b> oblong punch poinçon oblong	<b>Langlochstempel</b> oblong punch poinçon oblong	<b>Langloch-Winkelstahlmatrize längs</b> oblong offset die, longitudinal matrice oblongue décentrée	<b>Langloch-Winkelstahlmatrize quer</b> oblong offset die, transverse matrice oblongue décentrée
<b>Nr. 2</b>	<b>Nr. 5</b>	<b>Nr. 14</b>	<b>Nr. 14</b>
			
 Artikel-Nr.	 Artikel-Nr.	 Artikel-Nr.	 Artikel-Nr.
<b>5,5 x 14,0</b> 64002 3 055140	<b>5,5 x 25,0</b> 64005 3 055250 <b>6,5 x 26,0</b> 64005 3 065260 <b>7,5 x 26,0</b> 64005 3 075260	<b>6,2 x 14,7</b> 64214 3 062147 <b>6,2 x 25,7</b> 64214 3 062257 <b>7,2 x 26,7</b> 64214 3 072267 <b>8,2 x 26,7</b> 64214 3 082267	<b>6,2 x 14,7</b> 64214 4 062147 <b>6,2 x 25,7</b> 64214 4 062257 <b>7,2 x 26,7</b> 64214 4 072267 <b>8,2 x 26,7</b> 64214 4 082267
<b>9,0 x 14,0</b> 64002 3 090140	<b>9,0 x 26,0</b> 64005 3 090260 <b>10,0 x 20,0</b> 64005 3 100200 <b>11,0 x 22,0</b> 64005 3 110220 <b>11,0 x 26,0</b> 64005 3 110260 <b>13,0 x 26,0</b> 64005 3 130260 <b>14,0 x 26,0</b> 64005 3 140260 <b>16,0 x 26,0</b> 64005 3 160260	<b>9,7 x 14,7</b> 64214 3 097147 <b>9,7 x 26,7</b> 64214 3 097267 <b>10,7 x 20,7</b> 64214 3 107207 <b>11,7 x 22,7</b> 64214 3 117227 <b>11,7 x 26,7</b> 64214 3 117267 <b>13,7 x 26,7</b> 64214 3 137267 <b>14,7 x 26,7</b> 64214 3 147267 <b>16,7 x 26,7</b> 64214 3 167267	<b>9,7 x 14,7</b> 64214 4 097147 <b>9,7 x 26,7</b> 64214 4 097267 <b>10,7 x 20,7</b> 64214 4 107207 <b>11,7 x 22,7</b> 64214 4 117227 <b>11,7 x 26,7</b> 64214 4 117267 <b>13,7 x 26,7</b> 64214 4 137267 <b>14,7 x 26,7</b> 64214 4 147267 <b>16,7 x 26,7</b> 64214 4 167267

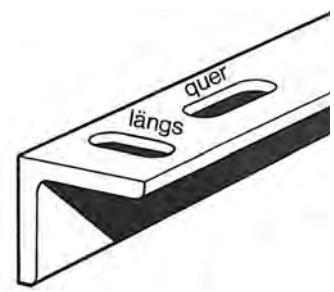

Streichmaß : siehe Seite **69**  
 back marks : see page  
 trusquinage : voir page

Grüne Serie • Green Series • Série verte

**Rechteckstempel**  
 rectangular punch  
 poinçon rectangulaire

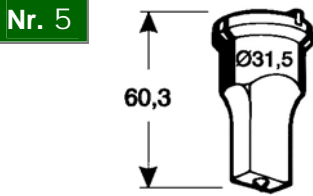

**Rechteckmatrize**  
 rectangular die  
 matrice rectangulaire

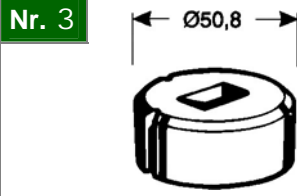

**Schlüssellochstempel\***  
 key hole punch  
 poinçon pour canon européen

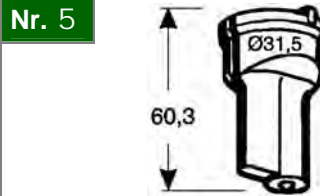

**Schlüssellochmatrize**  
 key hole die  
 matrice pour canon européen

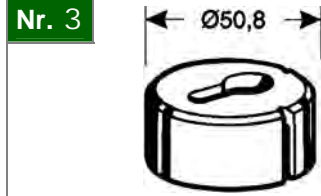

Artikel-Nr.

Artikel-Nr.

Artikel-Nr.

Artikel-Nr.

- 5,0x15 64005 5 050150
- 5,0x20 64005 5 050200
- 6,0x24 64005 5 060240
- 8,0x16 64005 5 080160
- 8,0x24 64005 5 080240
- 9,0x24 64005 5 090240
- 10,0x20 64005 5 100200
- 11,0x22 64005 5 110220
- 12,0x22 64005 5 120220
- 12,0x30 64005 5 120300
- 14,0x20 64005 5 140200
- 16,0x20 64005 5 160200

- 5,2x15,2 64203 5 052152
- 5,7x15,7 64203 5 057157
- 5,2x20,2 64203 5 052202
- 5,7x20,7 64203 5 057207
- 6,2x24,2 64203 5 062242
- 6,7x24,7 64203 5 067247
- 8,2x16,2 64203 5 082162
- 8,7x16,7 64203 5 087167
- 8,2x24,2 64203 5 082242
- 8,7x24,7 64203 5 087247
- 9,2x24,2 64203 5 092242
- 9,7x24,7 64203 5 097247
- 10,2x20,2 64203 5 102202
- 10,7x20,7 64203 5 107207
- 11,2x22,2 64203 5 112222
- 11,7x22,7 64203 5 117227
- 12,2x22,2 64203 5 122222
- 12,7x22,7 64203 5 127227
- 12,2x30,2 64203 5 122302
- 12,7x30,7 64203 5 127307
- 14,2x20,2 64203 5 142202
- 14,7x20,7 64203 5 147207
- 16,2x20,2 64203 5 162202
- 16,7x20,7 64203 5 167207

34,0 x Ø17,5 x 10,5  
 65005 17 001

34,2 x Ø17,7 x 10,7  
 65203 17 001

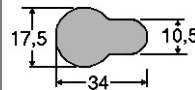

\*zusätzlich erforderlich:  
**Schnellspanneinsatz,  
 Schlüsselloch  
 42217 6 2002 02**  
 f. Stempel-Schnellwechsel-  
 vorrichtung – grüne Serie –  
 ab 1993

\*additionally required:  
 quick-change punch sleeve,  
 keyhole, p/n 42217 6 2002 02,  
 for quick-change punching  
 attachments, green series,  
 supplied since 1993

\*nécessaire en plus:  
 douille de serrage rapide,  
 canon européen,  
 réf. 42217 6 2002 02,  
 pour dispositifs de serrage rapide,  
 série verte, fournis depuis 1993

**Eckenabrundstempel**  
 corner radiusing punch  
 poinçon p. arrondir les angles

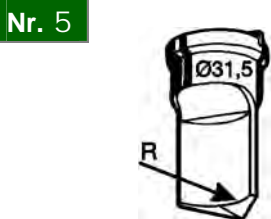

**Eckenabrundmatrize**  
 corner radiusing die  
 matrice p. arrondir les angles

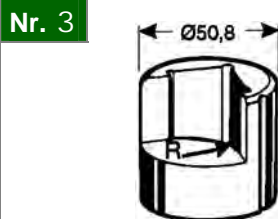

**Drehriegelstempel**  
 hasp hole punch  
 poinçon trou d'espagnolette

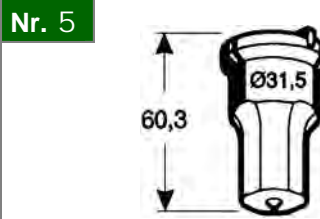

**Drehriegelmatrize**  
 hasp hole die  
 matrice trou d'espagnolette



Artikel-Nr.

Artikel-Nr.

Artikel-Nr.

Artikel-Nr.

- Radius**
- 5 65005 37 00050
  - 10 65005 37 00100
  - 15 65005 37 00150

- Radius**
- 5 65203 37 00050
  - 10 65203 37 00100
  - 14 65203 37 00140
  - 15 65203 37 00150

Ø 22,2x20,3 65005 38 222203

Ø 22,4 x20,5 65203 38 224205

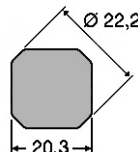

Grüne Serie • Green Series • Série verte

Spezial-Stempel zum Stanzen von VA-Material  
 Special Punches for Punching Stainless Steel  
 Poinçons spéciaux pour poinçonner du matériau inox

**Spezial-Rundstempel**  
 special round punch  
 poinçon rond spécial

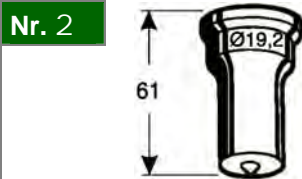

Artikel-Nr.
<b>3,0</b> P-65002 8012 030
<b>4,0</b> P-65002 8012 040
<b>4,5</b> P-65002 8012 045
<b>5,0</b> P-65002 8012 050
<b>5,5</b> P-65002 8012 055
<b>6,0</b> P-65002 8012 060
<b>6,5</b> P-65002 8012 065
<b>7,0</b> P-65002 8012 070
<b>8,0</b> P-65002 8012 080
<b>9,0</b> P-65002 8012 090
<b>10,0</b> P-65002 8012 100
<b>11,0</b> P-65002 8012 110
<b>12,0</b> P-65002 8012 120
<b>13,0</b> P-65002 8012 130
<b>14,0</b> P-65002 8012 140
<b>15,0</b> P-65002 8012 150
<b>16,0</b> P-65002 8012 160
<b>17,0</b> P-65002 8012 170

**Rundmatrize (Standard)**  
 round die  
 matrice ronde

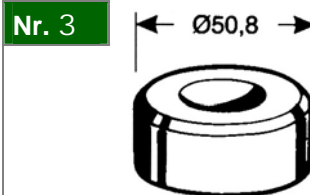

Artikel-Nr.
<b>3,2</b> 64203 1032
<b>3,7</b> 64203 1037
<b>4,2</b> 64203 1042
<b>4,7</b> 64203 1047
<b>5,2</b> 64203 1052
<b>5,7</b> 64203 1057
<b>6,2</b> 64203 1062
<b>6,7</b> 64203 1067
<b>7,2</b> 64203 1072
<b>7,7</b> 64203 1077
<b>8,2</b> 64203 1082
<b>8,7</b> 64203 1087
<b>9,2</b> 64203 1092
<b>9,7</b> 64203 1097
<b>10,2</b> 64203 1102
<b>10,7</b> 64203 1107

**Rundmatrize (Standard)**  
 round die  
 matrice ronde

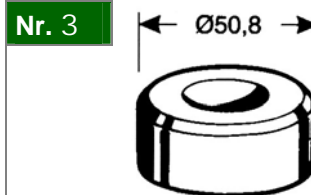

Artikel-Nr.
<b>11,2</b> 64203 1112
<b>11,7</b> 64203 1117
<b>12,2</b> 64203 1122
<b>12,7</b> 64203 1127
<b>13,2</b> 64203 1132
<b>13,7</b> 64203 1137
<b>14,2</b> 64203 1142
<b>14,7</b> 64203 1147
<b>15,2</b> 64203 1152
<b>15,7</b> 64203 1157
<b>16,2</b> 64203 1162
<b>16,7</b> 64203 1167
<b>17,2</b> 64203 1172
<b>17,7</b> 64203 1177
<b>18,2</b> 64203 1182

**Spezial-Vierkantstempel**  
 special square punch  
 poinçon carré spécial

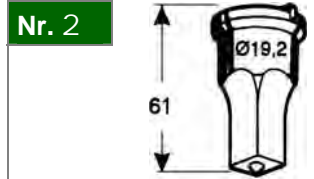

Artikel-Nr.
<b>9,0</b> P-65002 8014 090
<b>Vierkantmatrize (Standard)</b> square die matrice carrée
<b>Nr. 3</b>
<b>Artikel-Nr.</b>
<b>9,7</b> 64203 2097

**Spezial-Langlochstempel**  
 special oblong punch  
 poinçon oblong spécial

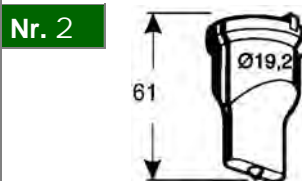

Artikel-Nr.
<b>5,1x10,0</b> P-65002 8013 02
<b>9,0x14,0</b> P-65002 8013 01
<b>9,0x18,0</b> P-65002 8013 03

**Langlochmatrize (Standard)**  
 oblong die  
 matrice oblongue



Artikel-Nr.
<b>9,7x14,7</b> 64203 3 097147
<b>9,7x18,7</b> 64203 3 097187

**Spezial-Langlochstempel**  
 special oblong punch  
 poinçon oblong spécial

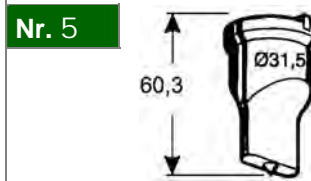

Artikel-Nr.
<b>9,0x25,0</b> P-65005 8024 02
<b>10,0x30,0</b> P-65005 8024 01
<b>11,0x26,0</b> P-65005 8024 04
<b>11,0x30,0</b> P-65005 8024 03

**Langlochmatrize (Standard)**  
 oblong die  
 matrice oblongue

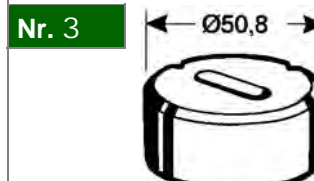

Artikel-Nr.
<b>9,7x25,7</b> 64203 3 097257
<b>10,7x30,7</b> 64203 3 107307
<b>11,2x31,2</b> 64203 3 112312
<b>11,7x26,7</b> 64203 3 117267
<b>12,2x27,2</b> 64203 3 122272
<b>11,7x30,7</b> 64203 3 117307
<b>12,2x31,2</b> 64203 3 122312