

Peddy • Peddicat 275H • 21/16 • 36 RP 10

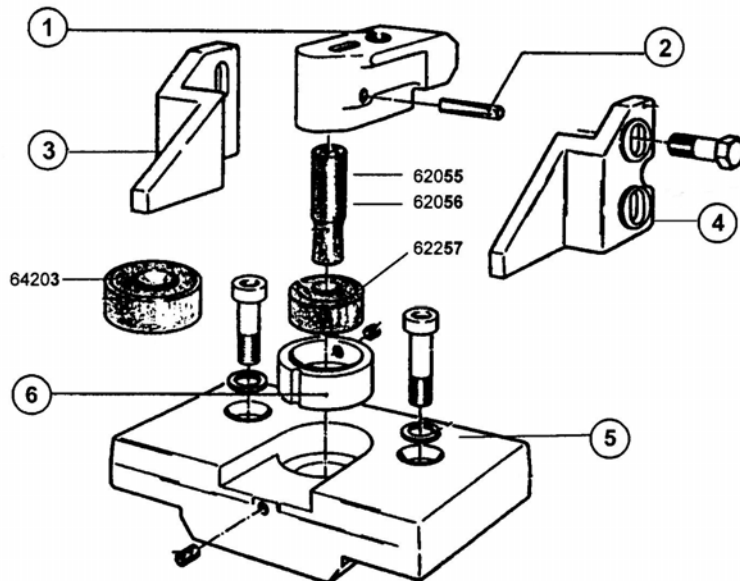

Peddy

ab Maschinen-Nr. • from serial no. • à partir du no. de fabr. • PA 2000



1	Stempelhalter punch holder porte-poinçon	40610 199 953 C
2	Stempelkeil taper pin clavette	40610 5 4081 02 M
3	Abstreifer links stripper, l.h. dévêtisseur à g.	40610 5 4081 06
4	Abstreifer rechts stripper, r.h. dévêtisseur à dr.	40610 5 4081 05
5	Matrizenhalter die holder porte-matrice	40610 199 954 E

nicht im Lieferumfang enthalten:
 not included in the scope of delivery.
 non compris de la livraison:

6	Reduziereinsatz reducing socket réducteur	40610 199 957
---	-------------------------------------------------	---------------

Normal-Stanzwerkzeug, komplett
 Standard punching attachment complete
 Dispositif de poinçonnage standard complet
 Artikel-Nr. 40610 5 4081 00 A

Peddy • Peddicat 275H • 21/16 • 36 RP 10

Rundstempel round punch poinçon rond	Rundstempel round punch poinçon rond	Rundmatrize round die matrice ronde	Rundmatrize round die matrice ronde	Rundmatrize round die matrice ronde
--------------------------------------------	--------------------------------------------	-------------------------------------------	-------------------------------------------	-------------------------------------------

Nr. 55	Nr. 56	Nr. 57	Nr. 3*	Nr. 3*
--------	--------	--------	--------	--------

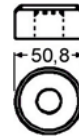
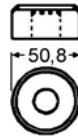
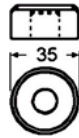
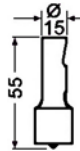
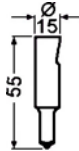

Artikel-Nr.	Artikel-Nr.	Artikel-Nr.	Artikel-Nr.	Artikel-Nr.
-------------	-------------	-------------	-------------	-------------

3,0	62055 1030	15,5	62056 1155	3,2	62257 1032	3,2	64203 1032	23,2	64203 1232
3,5	62055 1035	16,0	62056 1160	3,7	62257 1037	3,7	64203 1037	23,7	64203 1237
4,0	62055 1040	16,5	62056 1165	4,2	62257 1042	4,2	64203 1042	24,2	64203 1242
4,5	62055 1045	17,0	62056 1170	4,7	62257 1047	4,7	64203 1047	24,7	64203 1247
5,0	62055 1050	17,5	62056 1175	5,2	62257 1052	5,2	64203 1052	25,2	64203 1252
5,5	62055 1055	18,0	62056 1180	5,7	62257 1057	5,7	64203 1057	25,7	64203 1257
6,0	62055 1060	18,5	62056 1185	6,2	62257 1062	6,2	64203 1062	26,2	64203 1262
6,5	62055 1065	19,0	62056 1190	6,7	62257 1067	6,7	64203 1067	26,7	64203 1267
7,0	62055 1070	19,5	62056 1195	7,2	62257 1072	7,2	64203 1072	27,2	64203 1272
7,5	62055 1075	20,0	62056 1200	7,7	62257 1077	7,7	64203 1077	27,7	64203 1277
8,0	62055 1080	20,5	62056 1205	8,2	62257 1082	8,2	64203 1082	28,2	64203 1282
8,5	62055 1085	21,0	62056 1210	8,7	62257 1087	8,7	64203 1087	28,7	64203 1287
9,0	62055 1090	21,5	62056 1215	9,2	62257 1092	9,2	64203 1092	29,2	64203 1292
9,5	62055 1095	22,0	62056 1220	9,7	62257 1097	9,7	64203 1097	29,7	64203 1297
10,0	62055 1100			10,2	62257 1102	10,2	64203 1102	30,2	64203 1302
10,5	62055 1105			10,7	62257 1107	10,7	64203 1107	30,7	64203 1307
11,0	62055 1110			11,2	62257 1112	11,2	64203 1112		
11,5	62055 1115			11,7	62257 1117	11,7	64203 1117		
12,0	62055 1120			12,2	62257 1122	12,2	64203 1122		
12,5	62055 1125			12,7	62257 1127	12,7	64203 1127		
13,0	62055 1130			13,2	62257 1132	13,2	64203 1132		
13,5	62055 1135			13,7	62257 1137	13,7	64203 1137		
14,0	62055 1140			14,2	62257 1142	14,2	64203 1142		
14,5	62055 1145			14,7	62257 1147	14,7	64203 1147		
15,0	62055 1150			15,2	62257 1152	15,2	64203 1152		
				15,7	62257 1157	15,7	64203 1157		
				16,2	62257 1162	16,2	64203 1162		
				16,7	62257 1167	16,7	64203 1167		
				17,2	62257 1172	17,2	64203 1172		
				17,7	62257 1177	17,7	64203 1177		
				18,2	62257 1182	18,2	64203 1182		
				18,7	62257 1187	18,7	64203 1187		
				19,2	62257 1192	19,2	64203 1192		
				19,7	62257 1197	19,7	64203 1197		
				20,2	62257 1202	20,2	64203 1202		
				20,7	62257 1207	20,7	64203 1207		
				21,2	62257 1212	21,2	64203 1212		
				21,7	62257 1217	21,7	64203 1217		
				22,2	62257 1222	22,2	64203 1222		
				22,7	62257 1227	22,7	64203 1227		

Rundstempel
 round punch
 poinçon rond

Nr. 57*

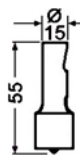

Artikel-Nr.	Artikel-Nr.
-------------	-------------

23,0	62057 1230
24,0	62057 1240
25,0	62057 1250
30,0	62057 1300

Stempelkeil
 taper pin
 clavette de poinçon

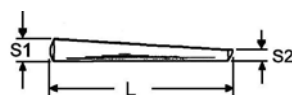

Artikel-Nr.
 40610 5 4081 02M

D Ø	S1	S2	L
5	4,4	3,2	40

*nur für
 *only for
 *uniquement pour

Peddy & Peddicat 275 H



Peddinghaus Anlagen & Maschinen GmbH

Peddinghaus Anlagen & Maschinen GmbH
 Hasslinghauser Str. 156 • D-58285 Gevelsberg
 Tel. +49 (0) 2332 / 6646-21/22/23
 Fax +49 (0) 2332 / 6646-46
 teile-pam@peddy.de • www.peddy.de

Peddy • Peddicat 275H • 21/16 • 36 RP 10

Vierkantstempel square punch poinçon carré	Vierkantstempel square punch poinçon carré	Vierkantmatrize square die matrice carrée	Vierkantmatrize square die matrice carrée	Schlüssellochstempel, quer keyhole punch, transverse poinçon pour canon européen
Nr. 55	Nr. 56	Nr. 57	Nr. 3*	Nr. 57*
Artikel-Nr.	Artikel-Nr.	Artikel-Nr.	Artikel-Nr.	Artikel-Nr.
4,0 62055 2040 5,0 62055 2050 6,0 62055 2060 7,0 62055 2070 8,0 62055 2080 9,0 62055 2090 10,0 62055 2100	11,0 62056 2110 12,0 62056 2120 13,0 62056 2130 14,0 62056 2140 15,0 62056 2150	4,2 62257 2042 4,7 62257 2047 5,2 62257 2052 5,7 62257 2057 6,2 62257 2062 6,7 62257 2067 7,2 62257 2072 7,7 62257 2077 8,2 62257 2082 8,7 62257 2087 9,2 62257 2092 9,7 62257 2097 10,2 62257 2102 10,7 62257 2107 11,2 62257 2112 11,7 62257 2117 12,2 62257 2122 12,7 62257 2127 13,2 62257 2132 13,7 62257 2137 14,2 62257 2142 14,7 62257 2147 15,2 62257 2152 15,7 62257 2157	4,2 64203 2042 4,7 64203 2047 5,2 64203 2052 5,7 64203 2057 6,2 64203 2062 6,7 64203 2067 7,2 64203 2072 7,7 64203 2077 8,2 64203 2082 8,7 64203 2087 9,2 64203 2092 9,7 64203 2097 10,2 64203 2102 10,7 64203 2107 11,2 64203 2112 11,7 64203 2117 12,2 64203 2122 12,7 64203 2127 13,2 64203 2132 13,7 64203 2137 14,2 64203 2142 14,7 64203 2147 15,2 64203 2152 15,7 64203 2157	34 × Ø 17,5 × 10,5 62057 17 001 Schlüssellochmatrize, quer keyhole die, transverse matrice pour canon européen <hr/> Nr. 3* Artikel-Nr. 34,2 × Ø 17,7 × 10,7 65203 17 001

Stempelkeil
 taper pin
 clavette de poinçon

Artikel-Nr.
 40610 5 4081 02M

D Ø	S1	S2	L
5	4,4	3,2	40

*nur für
 *only for
 *uniquement pour

Peddy & Peddicat 275 H

Peddy • Peddicat 275H • 21/16 • 36 RP 10

Langlochstempel oblong punch poinçon oblong	Langlochmatrize oblong die matrice oblongue	Langlochmatrize oblong die matrice oblongue	Langlochstempel oblong punch poinçon oblong	Langlochmatrize oblong die matrice oblongue
Nr. 55	Nr. 57	Nr. 3*	Nr. 57*	Nr. 3*
Artikel-Nr.	Artikel-Nr.	Artikel-Nr.	Artikel-Nr.	Artikel-Nr.
5,0×10,0 62055 3050100	5,2×10,2 62257 3052102	5,2×10,2 64203 3052102	6,5×26,0 62057 3065260	6,7×26,2 64203 3067262
5,5×14,0 62055 3055140	5,7×10,7 62257 3057107	5,7×10,7 64203 3057107	7,5×26,0 62057 3075260	7,2×26,7 64203 3072267
6,5×12,0 62055 3065120	5,7×14,2 62257 3057142	5,7×14,2 64203 3057142	9,0×26,0 62057 3090260	7,7×26,2 64203 3077262
7,5×14,0 62055 3075140	6,2×14,7 62257 3062147	6,2×14,7 64203 3062147	9,0×30,0 62057 3090300	8,2×26,7 64203 3082267
	6,7×12,2 62257 3067122	6,7×12,2 64203 3067122	10,0×26,0 62057 3100260	9,2×26,2 64203 3092262
	7,2×12,7 62257 3072127	7,2×12,7 64203 3072127	10,0×30,0 62057 3100300	9,7×26,7 64203 3097267
	7,7×14,2 62257 3077142	7,7×14,2 64203 3077142	11,0×26,0 62057 3110260	9,2×30,2 64203 3092302
	8,2×14,7 62257 3082147	8,2×14,7 64203 3082147	11,0×30,0 62057 3110300	9,7×30,7 64203 3097307
			12,0×26,0 62057 3120260	10,2×26,2 64203 3102262
			12,0×30,0 62057 3120300	10,7×26,7 64203 3107267
			13,0×26,0 62057 3130260	10,2×30,2 64203 3102302
			13,0×30,0 62057 3130300	10,7×30,7 64203 3107307
			14,0×28,0 62057 3140280	11,2×26,2 64203 3112262
				11,7×26,7 64203 3117267
				11,2×30,2 64203 3112302
				11,7×30,7 64203 3117307
				12,2×24,2 64203 3122242
				12,7×24,7 64203 3127247
				12,2×30,2 64203 3122302
				12,7×30,7 64203 3127307
				13,2×26,2 64203 3132262
				13,7×26,7 64203 3137267
				13,2×30,2 64203 3132302
				13,7×30,7 64203 3137307
				14,2×28,2 64203 3142282
				14,7×28,7 64203 3147287

Langlochstempel
oblong punch
poinçon oblong

Nr. 56

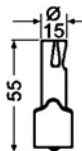

Artikel-Nr.

6,5×18,0	62056 3065180
7,5×21,0	65056 3075210
9,0×18,0	62056 3090180
10,0×20,0	62056 3100200
11,0×22,0	62056 3110220
12,0×20,0	62056 3120200

Stempelkeil
taper pin
clavette de poinçon

Artikel-Nr.
40610 5 4081 02M

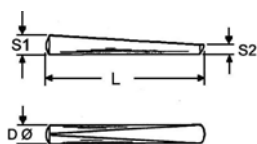

D Ø	S1	S2	L
5	4,4	3,2	40

*nur für
*only for
*uniquement pour

Peddy & Peddicat 275 H